



OM-198 076A

April 2000

Processes



MIG (GMAW) Welding
Flux Cored (FCAW) Welding

Description



Arc Welding Power Source And
Wire Feeder

Auto Arc[®] XLT 135 / 165

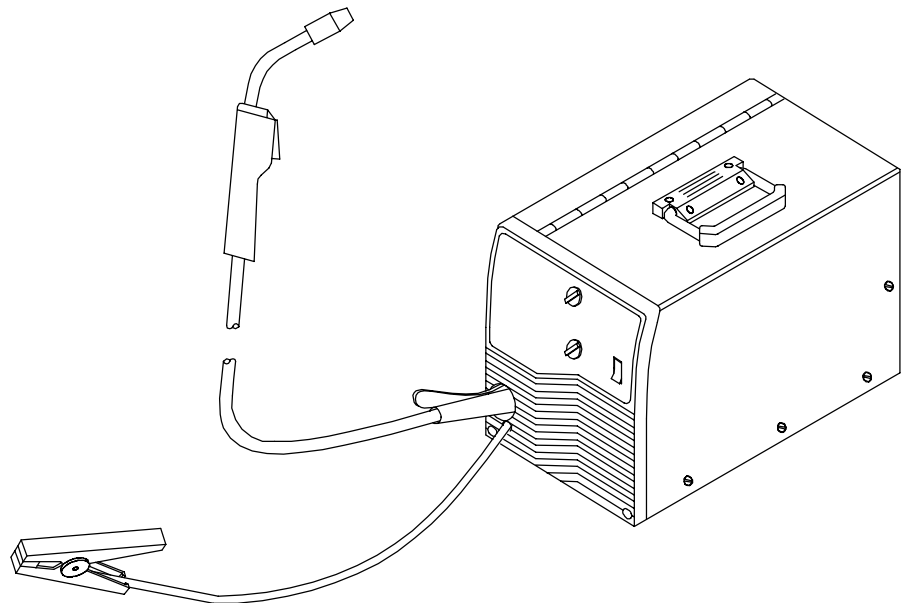

**For Warranty Claims And Technical Support, Contact:
Milweld Inc., National Distributor
P.O. Box 338, Hortonville, WI 54944-0338
Tel 920-779-0916 Fax 920-779-0924**

OWNER'S MANUAL

TABLE OF CONTENTS

WARNING

This product, when used for welding or cutting, produces fumes or gases which contain chemicals known to the State of California to cause birth defects and, in some cases, cancer. (California Health & Safety Code Section 25249.5 et seq.)

The following terms are used interchangeably throughout this manual:
MIG=GMAW

SECTION 1 – SAFETY PRECAUTIONS - READ BEFORE USING	1
1-1. Symbol Usage	1
1-2. Arc Welding Hazards	1
1-3. Additional Symbols For Installation, Operation, And Maintenance	3
1-4. Principal Safety Standards	3
1-5. EMF Information	4
SECTION 1 – CONSIGNES DE SECURITE – LIRE AVANT UTILISATION	5
1-1. Signification des symboles	5
1-2. Dangers relatifs au soudage à l'arc	5
1-3. Dangers supplémentaires en relation avec l'installation, le fonctionnement et la maintenance	7
1-4. Principales normes de sécurité	8
1-5. Information sur les champs électromagnétiques	8
SECTION 2 – SPECIFICATIONS	9
2-1. Specifications	9
2-2. Duty Cycle And Overheating	10
2-3. Volt-Ampere Curves	11
SECTION 3 – INSTALLATION	12
3-1. Installing Welding Gun	12
3-2. Installing Work Clamp	12
3-3. Process/Polarity Table	13
3-4. Changing Polarity	13
3-5. Installing Gas Supply	14
3-6. Selecting A Location And Connecting Input Power For 115 VAC Model	15
3-7. Selecting A Location And Connecting Input Power For 230 VAC Model	16
3-8. Electrical Service Guide For 230 VAC Model	17
3-9. Installing Wire Spool And Adjusting Hub Tension	17
3-10. Threading Welding Wire	18
SECTION 4 – OPERATION	19
4-1. Controls	19
4-2. Weld Parameters For 115 VAC Model	20
4-3. Weld Parameters For 230 VAC Model	21
SECTION 5 – MAINTENANCE & TROUBLESHOOTING	22
5-1. Routine Maintenance	22
5-2. Overload Protection	22
5-3. Drive Motor Protection	22
5-4. Changing Drive Roll Or Wire Inlet Guide	23
5-5. Replacing Gun Contact Tip	23
5-6. Cleaning Or Replacing Gun Liner	24
5-7. Replacing Switch And/Or Head Tube	25
5-8. Troubleshooting Table	26
SECTION 6 – ELECTRICAL DIAGRAM	27
SECTION 7 – MIG WELDING (GMAW) GUIDELINES	29
7-1. Typical MIG Process Connections	29
7-2. Typical MIG Process Control Settings	30
7-3. Holding And Positioning Welding Gun	31
7-4. Conditions That Affect Weld Bead Shape	32
7-5. Gun Movement During Welding	33
7-6. Poor Weld Bead Characteristics	33
7-7. Good Weld Bead Characteristics	33
7-8. Troubleshooting – Excessive Spatter	34
7-9. Troubleshooting – Porosity	34
7-10. Troubleshooting – Excessive Penetration	35
7-11. Troubleshooting – Lack Of Penetration	35
7-12. Troubleshooting – Incomplete Fusion	35
7-13. Troubleshooting – Burn-Through	36
7-14. Troubleshooting – Waviness Of Bead	36
7-15. Troubleshooting – Distortion	36
7-16. Common MIG Shielding Gases	37
SECTION 8 – PARTS LIST	38
WARRANTY	

SECTION 1 – SAFETY PRECAUTIONS - READ BEFORE USING

som_nd_4/98

1-1. Symbol Usage



Means Warning! Watch Out! There are possible hazards with this procedure! The possible hazards are shown in the adjoining symbols.

▲ Marks a special safety message.

☞ Means "Note"; not safety related.



This group of symbols means Warning! Watch Out! possible ELECTRIC SHOCK, MOVING PARTS, and HOT PARTS hazards. Consult symbols and related instructions below for necessary actions to avoid the hazards.

1-2. Arc Welding Hazards

▲ The symbols shown below are used throughout this manual to call attention to and identify possible hazards. When you see the symbol, watch out, and follow the related instructions to avoid the hazard. The safety information given below is only a summary of the more complete safety information found in the Safety Standards listed in Section 1-4. Read and follow all Safety Standards.

▲ Only qualified persons should install, operate, maintain, and repair this unit.

▲ During operation, keep everybody, especially children, away.



ELECTRIC SHOCK can kill.

Touching live electrical parts can cause fatal shocks or severe burns. The electrode and work circuit is electrically live whenever the output is on. The input power circuit and machine internal circuits are also

live when power is on. In semiautomatic or automatic wire welding, the wire, wire reel, drive roll housing, and all metal parts touching the welding wire are electrically live. Incorrectly installed or improperly grounded equipment is a hazard.

- Do not touch live electrical parts.
- Wear dry, hole-free insulating gloves and body protection.
- Insulate yourself from work and ground using dry insulating mats or covers big enough to prevent any physical contact with the work or ground.
- Do not use AC output in damp areas, if movement is confined, or if there is a danger of falling.
- Use AC output ONLY if required for the welding process.
- If AC output is required, use remote output control if present on unit.
- Disconnect input power or stop engine before installing or servicing this equipment. Lockout/tagout input power according to OSHA 29 CFR 1910.147 (see Safety Standards).
- Properly install and ground this equipment according to its Owner's Manual and national, state, and local codes.
- Always verify the supply ground – check and be sure that input power cord ground wire is properly connected to ground terminal in disconnect box or that cord plug is connected to a properly grounded receptacle outlet.
- When making input connections, attach proper grounding conductor first – double-check connections.
- Frequently inspect input power cord for damage or bare wiring – replace cord immediately if damaged – bare wiring can kill.
- Turn off all equipment when not in use.
- Do not use worn, damaged, undersized, or poorly spliced cables.
- Do not drape cables over your body.

- If earth grounding of the workpiece is required, ground it directly with a separate cable.
- Do not touch electrode if you are in contact with the work, ground, or another electrode from a different machine.
- Use only well-maintained equipment. Repair or replace damaged parts at once. Maintain unit according to manual.
- Wear a safety harness if working above floor level.
- Keep all panels and covers securely in place.
- Clamp work cable with good metal-to-metal contact to workpiece or worktable as near the weld as practical.
- Insulate work clamp when not connected to workpiece to prevent contact with any metal object.
- Do not connect more than one electrode or work cable to any single weld output terminal.

SIGNIFICANT DC VOLTAGE exists after removal of input power on inverters.

- Turn Off inverter, disconnect input power, and discharge input capacitors according to instructions in Maintenance Section before touching any parts.

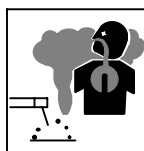

FUMES AND GASES can be hazardous.

Welding produces fumes and gases. Breathing these fumes and gases can be hazardous to your health.

- Keep your head out of the fumes. Do not breathe the fumes.
- If inside, ventilate the area and/or use exhaust at the arc to remove welding fumes and gases.
- If ventilation is poor, use an approved air-supplied respirator.
- Read the Material Safety Data Sheets (MSDSs) and the manufacturer's instructions for metals, consumables, coatings, cleaners, and degreasers.
- Work in a confined space only if it is well ventilated, or while wearing an air-supplied respirator. Always have a trained watch-person nearby. Welding fumes and gases can displace air and lower the oxygen level causing injury or death. Be sure the breathing air is safe.
- Do not weld in locations near degreasing, cleaning, or spraying operations. The heat and rays of the arc can react with vapors to form highly toxic and irritating gases.
- Do not weld on coated metals, such as galvanized, lead, or cadmium plated steel, unless the coating is removed from the weld area, the area is well ventilated, and if necessary, while wearing an air-supplied respirator. The coatings and any metals containing these elements can give off toxic fumes if welded.



ARC RAYS can burn eyes and skin.

Arc rays from the welding process produce intense visible and invisible (ultraviolet and infrared) rays that can burn eyes and skin. Sparks fly off from the weld.

- Wear a welding helmet fitted with a proper shade of filter to protect your face and eyes when welding or watching (see ANSI Z49.1 and Z87.1 listed in Safety Standards).
- Wear approved safety glasses with side shields under your helmet.
- Use protective screens or barriers to protect others from flash and glare; warn others not to watch the arc.
- Wear protective clothing made from durable, flame-resistant material (leather and wool) and foot protection.



WELDING can cause fire or explosion.

Welding on closed containers, such as tanks, drums, or pipes, can cause them to blow up. Sparks can fly off from the welding arc. The flying sparks, hot workpiece, and hot equipment can cause fires and burns. Accidental contact of electrode to metal objects can cause sparks, explosion, overheating, or fire. Check and be sure the area is safe before doing any welding.

- Protect yourself and others from flying sparks and hot metal.
- Do not weld where flying sparks can strike flammable material.
- Remove all flammables within 35 ft (10.7 m) of the welding arc. If this is not possible, tightly cover them with approved covers.
- Be alert that welding sparks and hot materials from welding can easily go through small cracks and openings to adjacent areas.
- Watch for fire, and keep a fire extinguisher nearby.
- Be aware that welding on a ceiling, floor, bulkhead, or partition can cause fire on the hidden side.
- Do not weld on closed containers such as tanks, drums, or pipes, unless they are properly prepared according to AWS F4.1 (see Safety Standards).
- Connect work cable to the work as close to the welding area as practical to prevent welding current from traveling long, possibly unknown paths and causing electric shock and fire hazards.
- Do not use welder to thaw frozen pipes.
- Remove stick electrode from holder or cut off welding wire at contact tip when not in use.
- Wear oil-free protective garments such as leather gloves, heavy shirt, cuffless trousers, high shoes, and a cap.
- Remove any combustibles, such as a butane lighter or matches, from your person before doing any welding.

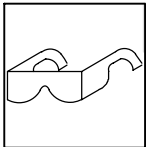

FLYING METAL can injure eyes.

- Welding, chipping, wire brushing, and grinding cause sparks and flying metal. As welds cool, they can throw off slag.
- Wear approved safety glasses with side shields even under your welding helmet.



BUILDUP OF GAS can injure or kill.

- Shut off shielding gas supply when not in use.
- Always ventilate confined spaces or use approved air-supplied respirator.



HOT PARTS can cause severe burns.

- Do not touch hot parts bare handed.
- Allow cooling period before working on gun or torch.

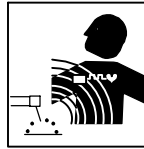

MAGNETIC FIELDS can affect pacemakers.

- Pacemaker wearers keep away.
- Wearers should consult their doctor before going near arc welding, gouging, or spot welding operations.

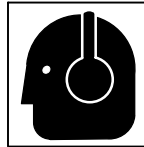

NOISE can damage hearing.

Noise from some processes or equipment can damage hearing.

- Wear approved ear protection if noise level is high.

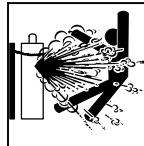

CYLINDERS can explode if damaged.

Shielding gas cylinders contain gas under high pressure. If damaged, a cylinder can explode. Since gas cylinders are normally part of the welding process, be sure to treat them carefully.

- Protect compressed gas cylinders from excessive heat, mechanical shocks, slag, open flames, sparks, and arcs.
- Install cylinders in an upright position by securing to a stationary support or cylinder rack to prevent falling or tipping.
- Keep cylinders away from any welding or other electrical circuits.
- Never drape a welding torch over a gas cylinder.
- Never allow a welding electrode to touch any cylinder.
- Never weld on a pressurized cylinder – explosion will result.
- Use only correct shielding gas cylinders, regulators, hoses, and fittings designed for the specific application; maintain them and associated parts in good condition.
- Turn face away from valve outlet when opening cylinder valve.
- Keep protective cap in place over valve except when cylinder is in use or connected for use.
- Read and follow instructions on compressed gas cylinders, associated equipment, and CGA publication P-1 listed in Safety Standards.

1-3. Additional Symbols For Installation, Operation, And Maintenance



FIRE OR EXPLOSION hazard.

- Do not install or place unit on, over, or near combustible surfaces.
- Do not install unit near flammables.
- Do not overload building wiring – be sure power supply system is properly sized, rated, and protected to handle this unit.



FALLING UNIT can cause injury.

- Use lifting eye to lift unit only, NOT running gear, gas cylinders, or any other accessories.
- Use equipment of adequate capacity to lift and support unit.
- If using lift forks to move unit, be sure forks are long enough to extend beyond opposite side of unit.

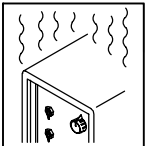

OVERUSE can cause OVERHEATING

- Allow cooling period; follow rated duty cycle.
- Reduce current or reduce duty cycle before starting to weld again.
- Do not block or filter airflow to unit.

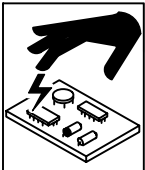

STATIC (ESD) can damage PC boards.

- Put on grounded wrist strap BEFORE handling boards or parts.
- Use proper static-proof bags and boxes to store, move, or ship PC boards.



MOVING PARTS can cause injury.

- Keep away from moving parts.
- Keep away from pinch points such as drive rolls.



WELDING WIRE can cause injury.

- Do not press gun trigger until instructed to do so.
- Do not point gun toward any part of the body, other people, or any metal when threading welding wire.



MOVING PARTS can cause injury.

- Keep away from moving parts such as fans.
- Keep all doors, panels, covers, and guards closed and securely in place.

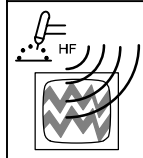

H.F. RADIATION can cause interference.

- High-frequency (H.F.) can interfere with radio navigation, safety services, computers, and communications equipment.
- Have only qualified persons familiar with electronic equipment perform this installation.
- The user is responsible for having a qualified electrician promptly correct any interference problem resulting from the installation.
- If notified by the FCC about interference, stop using the equipment at once.
- Have the installation regularly checked and maintained.
- Keep high-frequency source doors and panels tightly shut, keep spark gaps at correct setting, and use grounding and shielding to minimize the possibility of interference.

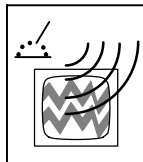

ARC WELDING can cause interference.

- Electromagnetic energy can interfere with sensitive electronic equipment such as computers and computer-driven equipment such as robots.
- Be sure all equipment in the welding area is electromagnetically compatible.
- To reduce possible interference, keep weld cables as short as possible, close together, and down low, such as on the floor.
- Locate welding operation 100 meters from any sensitive electronic equipment.
- Be sure this welding machine is installed and grounded according to this manual.
- If interference still occurs, the user must take extra measures such as moving the welding machine, using shielded cables, using line filters, or shielding the work area.

1-4. Principal Safety Standards

Safety in Welding and Cutting, ANSI Standard Z49.1, from American Welding Society, 550 N.W. LeJeune Rd, Miami FL 33126

Safety and Health Standards, OSHA 29 CFR 1910, from Superintendent of Documents, U.S. Government Printing Office, Washington, D.C. 20402.

Recommended Safe Practices for the Preparation for Welding and Cutting of Containers That Have Held Hazardous Substances, American Welding Society Standard AWS F4.1, from American Welding Society, 550 N.W. LeJeune Rd, Miami, FL 33126

National Electrical Code, NFPA Standard 70, from National Fire Protection Association, Batterymarch Park, Quincy, MA 02269.

Safe Handling of Compressed Gases in Cylinders, CGA Pamphlet P-1, from Compressed Gas Association, 1235 Jefferson Davis Highway, Suite 501, Arlington, VA 22202.

Code for Safety in Welding and Cutting, CSA Standard W117.2, from Canadian Standards Association, Standards Sales, 178 Rexdale Boulevard, Rexdale, Ontario, Canada M9W 1R3.

Safe Practices For Occupation And Educational Eye And Face Protection, ANSI Standard Z87.1, from American National Standards Institute, 1430 Broadway, New York, NY 10018.

Cutting And Welding Processes, NFPA Standard 51B, from National Fire Protection Association, Batterymarch Park, Quincy, MA 02269.

1-5. EMF Information

Considerations About Welding And The Effects Of Low Frequency Electric And Magnetic Fields

Welding current, as it flows through welding cables, will cause electromagnetic fields. There has been and still is some concern about such fields. However, after examining more than 500 studies spanning 17 years of research, a special blue ribbon committee of the National Research Council concluded that: "The body of evidence, in the committee's judgment, has not demonstrated that exposure to power-frequency electric and magnetic fields is a human-health hazard." However, studies are still going forth and evidence continues to be examined. Until the final conclusions of the research are reached, you may wish to minimize your exposure to electromagnetic fields when welding or cutting.

To reduce magnetic fields in the workplace, use the following procedures:

1. Keep cables close together by twisting or taping them.
2. Arrange cables to one side and away from the operator.
3. Do not coil or drape cables around your body.
4. Keep welding power source and cables as far away from operator as practical.
5. Connect work clamp to workpiece as close to the weld as possible.

About Pacemakers:

Pacemaker wearers consult your doctor first. If cleared by your doctor, then following the above procedures is recommended.

SECTION 1 – CONSIGNES DE SECURITE – LIRE AVANT UTILISATION

som_nd_fre 4/98

1-1. Signification des symboles



Signifie Mise en garde ! Soyez vigilant ! Cette procédure présente des risques de danger ! Ceux-ci sont identifiés par des symboles adjacents aux directives.

▲ Identifie un message de sécurité particulier.

Signifie NOTA ; n'est pas relatif à la sécurité.



Ce groupe de symboles signifie Mise en garde ! Soyez vigilant ! Il y a des risques de danger reliés aux CHOCS ÉLECTRIQUES, aux PIÈCES EN MOUVEMENT et aux PIÈCES CHAUDES. Reportez-vous aux symboles et aux directives ci-dessous afin de connaître les mesures à prendre pour éviter tout danger.

1-2. Dangers relatifs au soudage à l'arc

▲ Les symboles présentés ci-après sont utilisés tout au long du présent manuel pour attirer votre attention et identifier les risques de danger. Lorsque vous voyez un symbole, soyez vigilant et suivez les directives mentionnées afin d'éviter tout danger. Les consignes de sécurité présentées ci-après ne font que résumer l'information contenue dans les normes de sécurité énumérées à la section 1-4. Veuillez lire et respecter toutes ces normes de sécurité.

▲ L'installation, l'utilisation, l'entretien et les réparations ne doivent être confiés qu'à des personnes qualifiées.

▲ Au cours de l'utilisation, tenir toute personne à l'écart et plus particulièrement les enfants.



UN CHOC ÉLECTRIQUE peut tuer.

Un simple contact avec des pièces électriques peut provoquer une électrocution ou des blessures graves. L'électrode et le circuit de soudage sont sous tension dès que l'appareil est sur ON. Le circuit d'entrée et les circuits internes de l'appareil sont également sous tension à ce moment-là. En soudage semi-automatique ou automatique, le fil, le dévidoir, le logement des galets d'entraînement et les pièces métalliques en contact avec le fil de soudage sont sous tension. Des matériels mal installés ou mal mis à la terre présentent un danger.

- Ne jamais toucher les pièces électriques sous tension.
- Porter des gants et des vêtements de protection secs ne comportant pas de trous.
- S'isoler de la pièce et de la terre au moyen de tapis ou d'autres moyens isolants suffisamment grands pour empêcher le contact physique éventuel avec la pièce ou la terre.
- Ne pas se servir de source électrique à courant électrique dans les zones humides, dans les endroits confinés ou là où on risque de tomber.
- Se servir d'une source électrique à courant électrique UNIQUEMENT si le procédé de soudage le demande.
- Si l'utilisation d'une source électrique à courant électrique s'avère nécessaire, se servir de la fonction de télécommande si l'appareil en est équipé.
- Couper l'alimentation ou arrêter le moteur avant de procéder à l'installation, à la réparation ou à l'entretien de l'appareil. Déverrouiller l'alimentation selon la norme OSHA 29 CFR 1910.147 (voir normes de sécurité).
- Installer et mettre à la terre correctement cet appareil conformément à son manuel d'utilisation et aux codes nationaux, provinciaux et municipaux.
- Toujours vérifier la terre du cordon d'alimentation – Vérifier et s'assurer que le fil de terre du cordon d'alimentation est bien raccordé à la borne de terre du sectionneur ou que la fiche du cordon est raccordée à une prise correctement mise à la terre.
- En effectuant les raccordements d'entrée fixer d'abord le conducteur de mise à la terre approprié et contre-vérifier les connexions.
- Vérifier fréquemment le cordon d'alimentation pour voir s'il n'est pas endommagé ou dénudé – remplacer le cordon immédiatement s'il est endommagé – un câble dénudé peut provoquer une électrocution.
- Mettre l'appareil hors tension quand on ne l'utilise pas.
- Ne pas utiliser des câbles usés, endommagés, de grosseur insuffisante ou mal épissés.
- Ne pas enrouler les câbles autour du corps.
- Si la pièce soudée doit être mise à la terre, le faire directement avec un câble distinct.
- Ne pas toucher l'électrode quand on est en contact avec la pièce, la terre ou une électrode provenant d'une autre machine.

- N'utiliser qu'un matériel en bon état. Réparer ou remplacer sur-le-champ les pièces endommagées. Entretien l'appareil conformément à ce manuel.
- Porter un harnais de sécurité quand on travaille en hauteur.
- Maintenir solidement en place tous les panneaux et capots.
- Fixer le câble de retour de façon à obtenir un bon contact métal-métal avec la pièce à souder ou la table de travail, le plus près possible de la soudure.
- Isoler la pince de masse quand pas mis à la pièce pour éviter le contact avec tout objet métallique.

Il y a DU COURANT CONTINU IMPORTANT dans les convertisseurs après la suppression de l'alimentation électrique.

- Arrêter les convertisseurs, débrancher le courant électrique, et décharger les condensateurs d'alimentation selon les instructions indiquées dans la partie entretien avant de toucher les pièces.

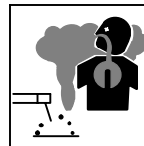

LES FUMÉES ET LES GAZ peuvent être dangereux.

Le soudage génère des fumées et des gaz. Leur inhalation peut être dangereuse pour votre santé.

- Eloigner votre tête des fumées. Ne pas respirer les fumées.
- A l'intérieur, ventiler la zone et/ou utiliser un échappement au niveau de l'arc pour l'évacuation des fumées et des gaz de soudage.
- Si la ventilation est insuffisante, utiliser un respirateur à alimentation d'air homologué.
- Lire les spécifications de sécurité des matériaux (MSDSs) et les instructions du fabricant concernant les métaux, les consommables, les revêtements, les nettoyants et les dégraissants.
- Travailler dans un espace fermé seulement s'il est bien ventilé ou en portant un respirateur à alimentation d'air. Demander toujours à un surveillant dûment formé de se tenir à proximité. Des fumées et des gaz de soudage peuvent déplacer l'air et abaisser le niveau d'oxygène provoquant des blessures ou des accidents mortels. S'assurer que l'air de respiration ne présente aucun danger.
- Ne pas souder dans des endroits situés à proximité d'opérations de dégraissage, de nettoyage ou de pulvérisation. La chaleur et des rayons de l'arc peuvent réagir en présence de vapeurs et former des gaz hautement toxiques et irritants.
- Ne pas souder des métaux munis d'un revêtement, tels que l'acier galvanisé, plaqué en plomb ou au cadmium à moins que le revêtement n'ait été enlevé dans la zone de soudure, que l'endroit soit bien ventilé, et si nécessaire, en portant un respirateur à alimentation d'air. Les revêtements et tous les métaux renfermant ces éléments peuvent dégager des fumées toxiques en cas de soudage.



LES RAYONS DE L'ARC peuvent provoquer des brûlures dans les yeux et sur la peau.

Le rayonnement de l'arc du procédé de soudage génère des rayons visibles et invisibles intenses (ultraviolets et infrarouges) susceptibles de provoquer des brûlures dans les yeux et sur la peau. Des étincelles sont projetées pendant le soudage.

- Porter un casque de soudage muni d'un écran de filtre approprié pour protéger votre visage et vos yeux pendant le soudage ou pour regarder (voir ANSI Z49.1 et Z87.1 énuméré dans les normes de sécurité).
- Porter des protections approuvés pour les oreilles si le niveau sonore est trop élevé.
- Utiliser des écrans ou des barrières pour protéger des tiers de l'éclair et de l'éblouissement; demander aux autres personnes de ne pas regarder l'arc.
- Porter des vêtements de protection constitué dans une matière durable, résistant au feu (cuir ou laine) et une protection des pieds.



LE SOUDAGE peut provoquer un incendie ou une explosion.

Le soudage effectué sur des conteneurs fermés tels que des réservoirs, tambours ou des conduites peut provoquer leur éclatement. Des étincelles peuvent être projetées de l'arc de soudure. La projection d'étincelles, des pièces chaudes et des équipements chauds peut provoquer des incendies et des brûlures. Le contact accidentel de l'électrode avec des objets métalliques peut provoquer des étincelles, une explosion, un surchauffement ou un incendie. Avant de commencer le soudage, vérifier et s'assurer que l'endroit ne présente pas de danger.

- Se protéger et d'autres personnes de la projection d'étincelles et de métal chaud.
- Ne pas souder dans un endroit là où des étincelles peuvent tomber sur des substances inflammables.
- Déplacer toutes les substances inflammables à une distance de 10,7 m de l'arc de soudage. En cas d'impossibilité les recouvrir soigneusement avec des protections homologués.
- Des étincelles et des matériaux chauds du soudage peuvent facilement passer dans d'autres zones en traversant de petites fissures et des ouvertures.
- Surveiller tout déclenchement d'incendie et tenir un extincteur à proximité.
- Le soudage effectué sur un plafond, plancher, paroi ou séparation peut déclencher un incendie de l'autre côté.
- Ne pas effectuer le soudage sur des conteneurs fermés tels que des réservoirs, tambours, ou conduites, à moins qu'ils n'aient été préparés correctement conformément à AWS F4.1 (voir les normes de sécurité).
- Brancher le câble sur la pièce le plus près possible de la zone de soudage pour éviter le transport du courant sur une longue distance par des chemins inconnus éventuels en provoquant des risques d'électrocution et d'incendie.
- Ne pas utiliser le poste de soudage pour dégeler des conduites gelées.
- En cas de non utilisation, enlever la baguette d'électrode du porte-électrode ou couper le fil à la pointe de contact.
- Porter des vêtements de protection dépourvus d'huile tels que des gants en cuir, une chemise en matériau lourd, des pantalons sans revers, des chaussures hautes et un couvre chef.
- Avant de souder, retirer toute substance combustible de vos poches telles qu'un allumeur au butane ou des allumettes.

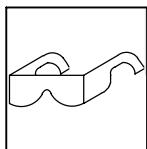

DES PARTICULES VOLANTES peuvent blesser les yeux.

- Le soudage, l'écaillage, le passage de la pièce à la brosse en fil de fer, et le meulage génèrent des étincelles et des particules métalliques volantes. Pendant la période de refroidissement des soudures, elles risquent de projeter du laitier.
 - Porter des lunettes de sécurité avec écrans latéraux ou un écran facial.



LES ACCUMULATIONS DE GAZ risquent de provoquer des blessures ou même la mort.

- Fermer l'alimentation du gaz protecteur en cas de non utilisation.
- Veiller toujours à bien aérer les espaces confinés ou se servir d'un respirateur d'adduction d'air homologué.

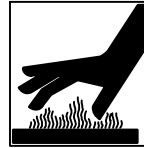

DES PIÈCES CHAUDES peuvent provoquer des brûlures graves.

- Ne pas toucher des parties chaudes à mains nues
- Prévoir une période de refroidissement avant d'utiliser le pistolet ou la torche.

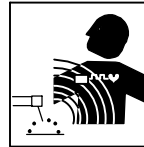

LES CHAMPS MAGNÉTIQUES peuvent affecter les stimulateurs cardiaques.

- Porteurs de stimulateur cardiaque, restez à distance.
- Les porteurs d'un stimulateur cardiaque doivent d'abord consulter leur médecin avant de s'approcher des opérations de soudage à l'arc, de gougeage ou de soudage par points.

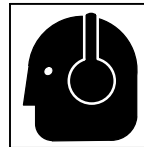

LE BRUIT peut affecter l'ouïe.

Le bruit des processus et des équipements peut affecter l'ouïe.

- Porter des protections approuvés pour les oreilles si le niveau sonore est trop élevé.

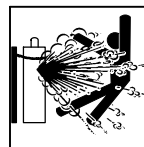

Si des BOUTEILLES sont endommagées, elles pourront exploser.

Des bouteilles de gaz protecteur contiennent du gaz sous haute pression. Si une bouteille est endommagée, elle peut exploser. Du fait que les bouteilles de gaz font normalement partie du procédé de soudage, les manipuler avec précaution.

- Protéger les bouteilles de gaz comprimé d'une chaleur excessive, des chocs mécaniques, du laitier, des flammes ouvertes, des étincelles et des arcs.
- Placer les bouteilles debout en les fixant dans un support stationnaire ou dans un porte-bouteilles pour les empêcher de tomber ou de se renverser.
- Tenir les bouteilles éloignées des circuits de soudage ou autres circuits électriques.
- Ne jamais placer une torche de soudage sur une bouteille à gaz.
- Une électrode de soudage ne doit jamais entrer en contact avec une bouteille.
- Ne jamais souder une bouteille pressurisée – risque d'explosion.
- Utiliser seulement des bouteilles de gaz protecteur, régulateurs, tuyaux et raccords convenables pour cette application spécifique; les maintenir ainsi que les éléments associés en bon état.
- Ne pas tenir la tête en face de la sortie en ouvrant la soupape de la bouteille.
- Maintenir le chapeau de protection sur la soupape, sauf en cas d'utilisation ou de branchement de la bouteille.
- Lire et suivre les instructions concernant les bouteilles de gaz comprimé, les équipements associés et les publications P-1 CGA énumérées dans les normes de sécurité.

1-3. Dangers supplémentaires en relation avec l'installation, le fonctionnement et la maintenance



Risque D'INCENDIE OU D'EXPLOSION.

- Ne pas placer l'appareil sur, au-dessus ou à proximité de surfaces inflammables.
- Ne pas installer l'appareil à proximité de produits inflammables
- Ne pas surcharger l'installation électrique – s'assurer que l'alimentation est correctement dimensionnée et protégé avant de mettre l'appareil en service.



LA CHUTE DE L'APPAREIL peut blesser.

- Utiliser l'anneau de levage uniquement pour soulever l'appareil, NON PAS les chariot, les bouteilles de gaz ou tout autre accessoire.
- Utiliser un engin d'une capacité appropriée pour soulever l'appareil.
- En utilisant des fourches de levage pour déplacer l'unité, s'assurer que les fourches sont suffisamment longues pour dépasser du côté opposé de l'appareil.

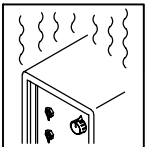

L'EMPLOI EXCESSIF peut SURCHAUFFER L'ÉQUIPEMENT.

- Prévoir une période de refroidissement, respecter le cycle opératoire nominal.
- Réduire le courant ou le cycle opératoire avant de recommencer le soudage.
- Ne pas obstruer les passages d'air du poste.

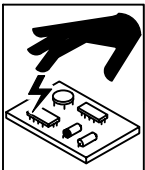

LES CHARGES ÉLECTROSTATIQUES peuvent endommager les circuits imprimés.

- Établir la connexion avec la barrette de terre avant de manipuler des cartes ou des pièces.
- Utiliser des pochettes et des boîtes antistatiques pour stocker, déplacer ou expédier des cartes de circuits imprimés.



DES ORGANES MOBILES peuvent provoquer des blessures.

- Ne pas s'approcher des organes mobiles.
- Ne pas s'approcher des points de coincement tels que des rouleaux de commande.



LES FILS DE SOUDAGE peuvent provoquer des blessures.

- Ne pas appuyer sur la gâchette avant d'en avoir reçu l'instruction.
- Ne pas diriger le pistolet vers soi, d'autres personnes ou toute pièce mécanique en engageant le fil de soudage.



DES ORGANES MOBILES peuvent provoquer des blessures.

- Rester à l'écart des organes mobiles comme le ventilateur.
- Maintenir fermés et fixement en place les portes, panneaux, recouvrements et dispositifs de protection.

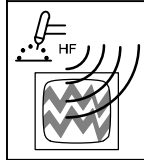

LE RAYONNEMENT HAUTE FRÉQUENCE (H.F.) risque de provoquer des interférences.

- Le rayonnement haute fréquence peut provoquer des interférences avec les équipements de radio-navigation et de communication, les services de sécurité et les ordinateurs.
- Demander seulement à des personnes qualifiées familiarisées avec des équipements électroniques de faire fonctionner l'installation.
- L'utilisateur est tenu de faire corriger rapidement par un électricien qualifié les interférences résultant de l'installation.
- Si le FCC signale des interférences, arrêter immédiatement l'appareil.
- Effectuer régulièrement le contrôle et l'entretien de l'installation.
- Maintenir soigneusement fermés les portes et les panneaux des sources de haute fréquence, maintenir les éclateurs à une distance correcte et utiliser une terre et un blindage pour réduire les interférences éventuelles.

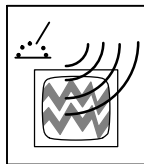

LE SOUDAGE À L'ARC risque de provoquer des interférences.

- L'énergie électromagnétique risque de provoquer des interférences pour l'équipement électronique sensible tel que les ordinateurs et l'équipement commandé par ordinateur tel que les robots.
- Veiller à ce que tout l'équipement de la zone de soudage soit compatible électromagnétiquement.
- Pour réduire la possibilité d'interférence, maintenir les câbles de soudage aussi courts que possible, les grouper, et les poser aussi bas que possible (ex. par terre).
- Veiller à souder à une distance de 100 mètres de tout équipement électronique sensible.
- Veiller à ce que ce poste de soudage soit posé et mis à la terre conformément à ce mode d'emploi.
- En cas d'interférences après avoir pris les mesures précédentes, il incombe à l'utilisateur de prendre des mesures supplémentaires telles que le déplacement du poste, l'utilisation de câbles blindés, l'utilisation de filtres de ligne ou la pose de protecteurs dans la zone de travail.

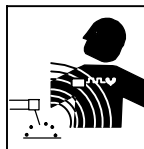

LES CHAMPS MAGNÉTIQUES peuvent affecter les stimulateurs cardiaques.

- Porteurs de stimulateur cardiaque, restez à distance.
- Les porteurs d'un stimulateur cardiaque doivent d'abord consulter leur médecin avant de s'approcher des opérations de soudage à l'arc, de gougeage ou de soudage par points.

1-4. Principales normes de sécurité

Safety in Welding and Cutting, norme ANSI Z49.1, de l'American Welding Society, 550 N.W. Lejeune Rd, Miami FL 33126

Safety and Health Standards, OSHA 29 CFR 1910, du Superintendent of Documents, U.S. Government Printing Office, Washington, D.C. 20402.

Recommended Safe Practice for the Preparation for Welding and Cutting of Containers That Have Held Hazardous Substances, norme AWS F4.1, de l'American Welding Society, 550 N.W. Lejeune Rd, Miami FL 33126

National Electrical Code, NFPA Standard 70, de la National Fire Protection Association, Batterymarch Park, Quincy, MA 02269.

Safe Handling of Compressed Gases in Cylinders, CGA Pamphlet P-1, de la Compressed Gas Association, 1235 Jefferson Davis Highway, Suite 501, Arlington, VA 22202.

Règles de sécurité en soudage, coupage et procédés connexes, norme CSA W117.2, de l'Association canadienne de normalisation, vente de normes, 178 Rexdale Boulevard, Rexdale (Ontario) Canada M9W 1R3.

Safe Practices For Occupation And Educational Eye And Face Protection, norme ANSI Z87.1, de l'American National Standards Institute, 1430 Broadway, New York, NY 10018.

Cutting and Welding Processes, norme NFPA 51B, de la National Fire Protection Association, Batterymarch Park, Quincy, MA 02269.

1-5. Information sur les champs électromagnétiques

Données sur le soudage électrique et sur les effets, pour l'organisme, des champs magnétiques basse fréquence

Le courant de soudage, pendant son passage dans les câbles de soudage, causera des champs électromagnétiques. Il y a eu et il y a encore un certain souci à propos de tels champs. Cependant, après avoir examiné plus de 500 études qui ont été faites pendant une période de recherche de 17 ans, un comité spécial ruban bleu du National Research Council a conclu: "L'accumulation de preuves, suivant le jugement du comité, n'a pas démontré que l'exposition aux champs magnétiques et champs électriques à haute fréquence représente un risque à la santé humaine". Toutefois, des études sont toujours en cours et les preuves continuent à être examinées. En attendant que les conclusions finales de la recherche soient établies, il vous serait souhaitable de réduire votre exposition aux champs électromagnétiques pendant le soudage ou le coupage.

Afin de réduire les champs électromagnétiques dans l'environnement de travail, respecter les consignes suivantes :

- 1 Garder les câbles ensemble en les torsadant ou en les attachant avec du ruban adhésif.
- 2 Mettre tous les câbles du côté opposé de l'opérateur.
- 3 Ne pas courber pas et ne pas entourer pas les câbles autour de votre corps.
- 4 Garder le poste de soudage et les câbles le plus loin possible de vous.
- 5 Relier la pince de masse le plus près possible de la zone de soudure.

Consignes relatives aux stimulateurs cardiaques :

Les personnes qui portent un stimulateur cardiaque doivent avant tout consulter leur docteur. Si vous êtes déclaré apte par votre docteur, il est alors recommandé de respecter les consignes ci-dessus.

SECTION 2 – SPECIFICATIONS

2-1. Specifications

A. 115 VAC Model

Rated Welding Output	Amperage Range	Maximum Open-Circuit Voltage DC	Amperes Input at Rated Load Output 115 V, 60 Hz, Single-Phase	KVA	KW	Weight W/ Gun	Overall Dimensions
90 A @ 19 Volts DC, 20% Duty Cycle 63 A @ 21 Volts DC, 20% Duty Cycle*	30 – 135	28	20 15*	2.90 2.20*	2.50 1.77*	55 lb (25 kg)	Length: 18-7/8 in (479 mm) Width: 10-5/8 in (270 mm) Height: 12-3/8 in (314 mm)
Wire Type And Dia	Solid/ Stainless	Flux Cored/ Aluminum	Wire Feed Speed Range				
	.023 – .030 in (0.6 – 0.8 mm)	.030 – .045 in (0.8 – 1.1 mm)/ .030 – .035 in (0.8 – 0.9 mm)	370 – 840 IPM (9.2 – 21.8 m/min) At No Load 50 – 800 IPM (1.3 – 20.3 m/min) Feeding Wire				
* CSA Rating							

B. 230 VAC Model

Rated Welding Output	Amperage Range	Maximum Open-Circuit Voltage DC	Amperes Input at Rated Load Output 230 V, 50/60 Hz, Single-Phase	KVA	KW	Weight W/ Gun	Overall Dimensions
130 A @ 20 Volts DC, 30% Duty Cycle At 60 Hz Input – 20% Duty Cycle At 50 Hz Input	30 – 175	30	19.5	4.60	3.75	65 lb (29.5 kg)	Length: 18-7/8 in (479 mm) Width: 10-5/8 in (270 mm) Height: 12-3/8 in (314 mm)
Wire Type And Dia	Solid/ Stainless	Flux Cored/ Aluminum	Wire Feed Speed Range				
	.023 – .035 in (0.6 – 0.9 mm)	.030 – .045 in (0.8 – 1.2 mm)/ .030 – .035 in (0.8 – 0.9 mm)	350 – 900 IPM (9.0 – 23.0 m/min) At No Load 50 – 850 IPM (1.3 – 20.3 m/min) Feeding Wire				

2-2. Duty Cycle And Overheating



Duty Cycle is percentage of 10 minutes that unit can weld at rated load without overheating.

If unit overheats, thermostat(s) opens, output stops, and cooling fan runs. Wait fifteen minutes for unit to cool. Reduce amperage or duty cycle before welding.

▲ Exceeding duty cycle can damage unit or gun and void warranty.

A. 115 VAC Model

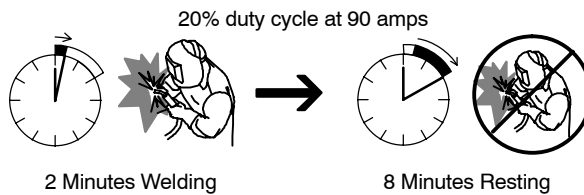
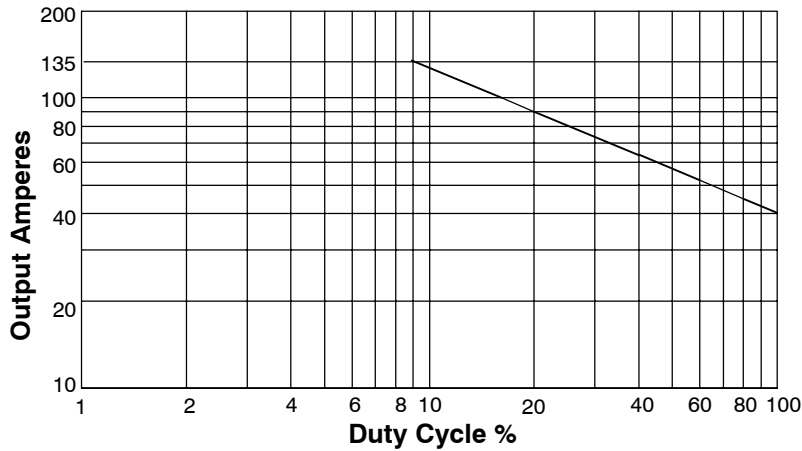

B. 230 VAC Model

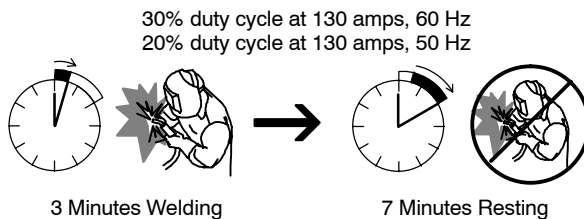
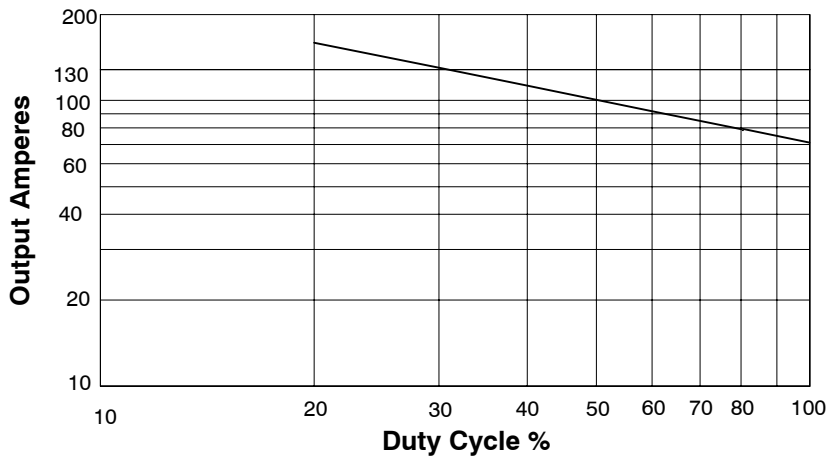

Overheating

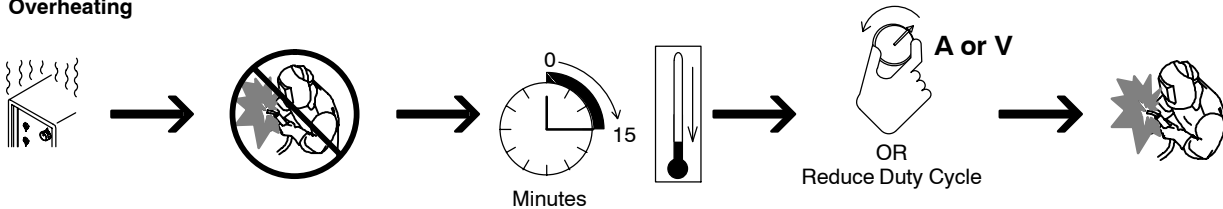

2-3. Volt-Ampere Curves

A. 115 VAC Model

The volt-ampere curves show the minimum and maximum voltage and amperage output capabilities of the welding power source. Curves of other settings fall between the curves shown.

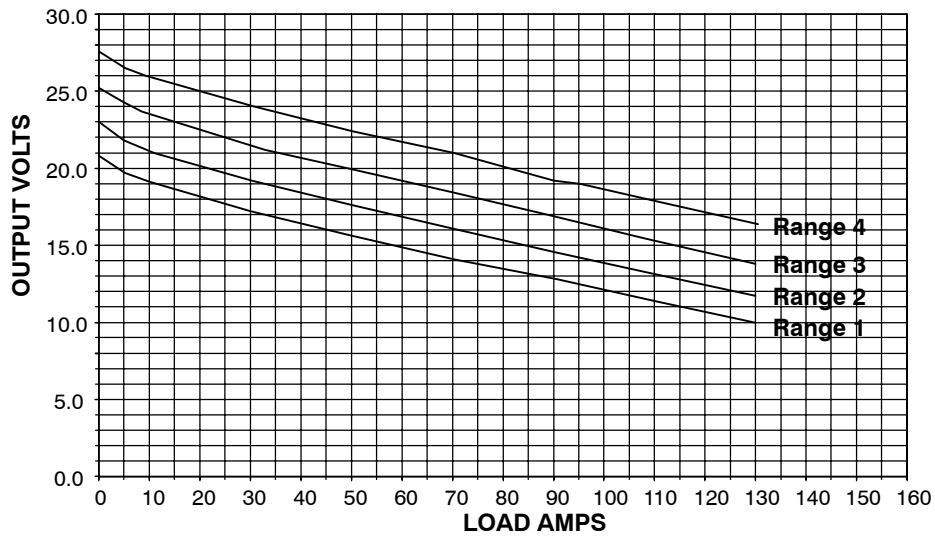

B. 230 VAC Model

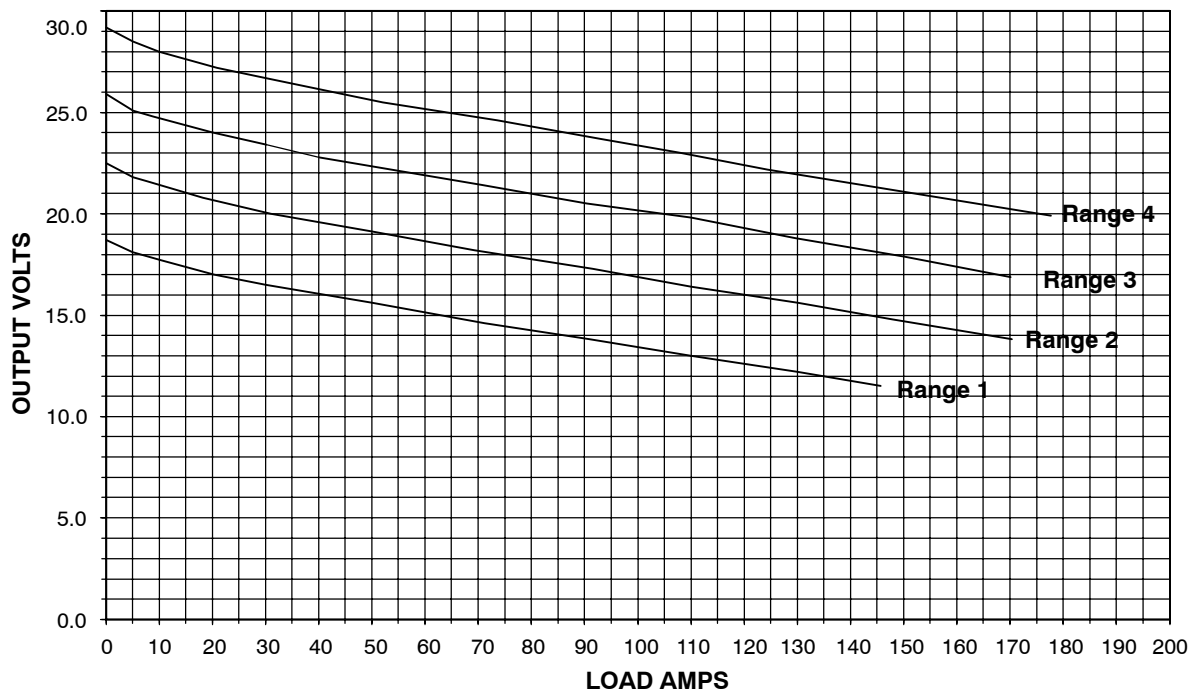

SECTION 3 – INSTALLATION

3-1. Installing Welding Gun

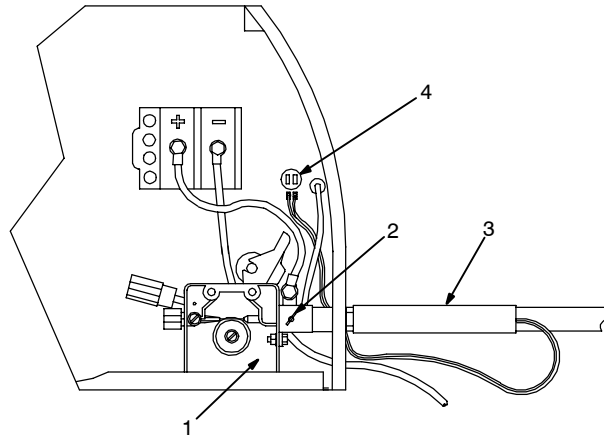

- 1 Drive Assembly
- 2 Gun Securing Thumbscrew
- 3 Gun End

Loosen thumbscrew. Insert gun end through opening until it bottoms against drive assembly. Tighten thumbscrew.

- 4 Gun Trigger Leads

Insert leads, one at a time, through gun opening on front panel. Connect female friction terminals to matching male terminals in unit. Polarity is not important.

Close door.

Ref. 802 440

3-2. Installing Work Clamp

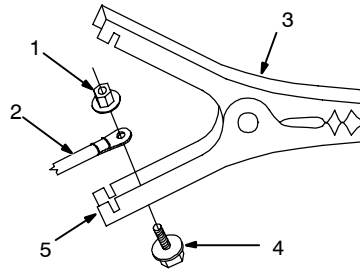

- 1 Nut
 - 2 Work Cable From Unit
 - 3 Work Clamp
 - 4 Screw
 - 5 Work Clamp Tabs
- Bend tabs around work cable.

Tools Needed:



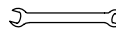

 3/8, 7/16 in

802 456

3-3. Process/Polarity Table

Process	Polarity	Cable Connections	
		Cable To Gun	Cable To Work
GMAW – Solid wire with shielding gas	DCEP – Reverse polarity	Connect to positive (+) output terminal	Connect to negative (-) output terminal
FCAW – Self-shielding wire – no shielding gas	DCEN – Straight Polarity	Connect to negative (-) output terminal	Connect to positive (+) output terminal

3-4. Changing Polarity





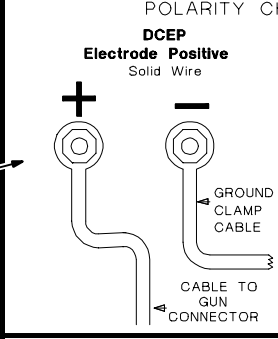
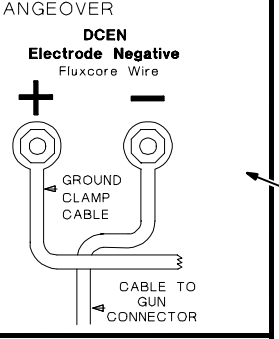

POLARITY CHANGEOVER

<p>DCEP Electrode Positive Solid Wire</p> 	<p>DCEN Electrode Negative Fluxcore Wire</p> 
--	--

WARNING

Do Not Remove This Label—Nes pas enlever l'etiquette

	<p>ELECTRIC SHOCK can be fatal. Feed roll assembly operates at welding voltage. Avoid bare skin contact.</p>
	<p>MOVING PARTS can cause injury</p> <ul style="list-style-type: none"> ● Keep away from moving parts. ● Keep all doors, panels, covers, and guards closed and securely in place.
	<p>AVERTISSEMENT</p> <p>UNE SECOUSSE ELECTRIQUE peut etre mortelle. L'assemblage des galets d'alimentation fonctionne a la tension de soudage. Attention eviter tout avec la peau. Ⓢ</p>

- 1 Lead Connections For Direct Current Electrode Positive (DCEP)
- 2 Lead Connections For Direct Current Electrode Negative (DCEN)

Always read and follow wire manufacturer's recommended polarity, and see Section 3-3.

Close door.

Ref. 196 052

3-5. Installing Gas Supply



Tools Needed:
 5/8, 1-1/8 in

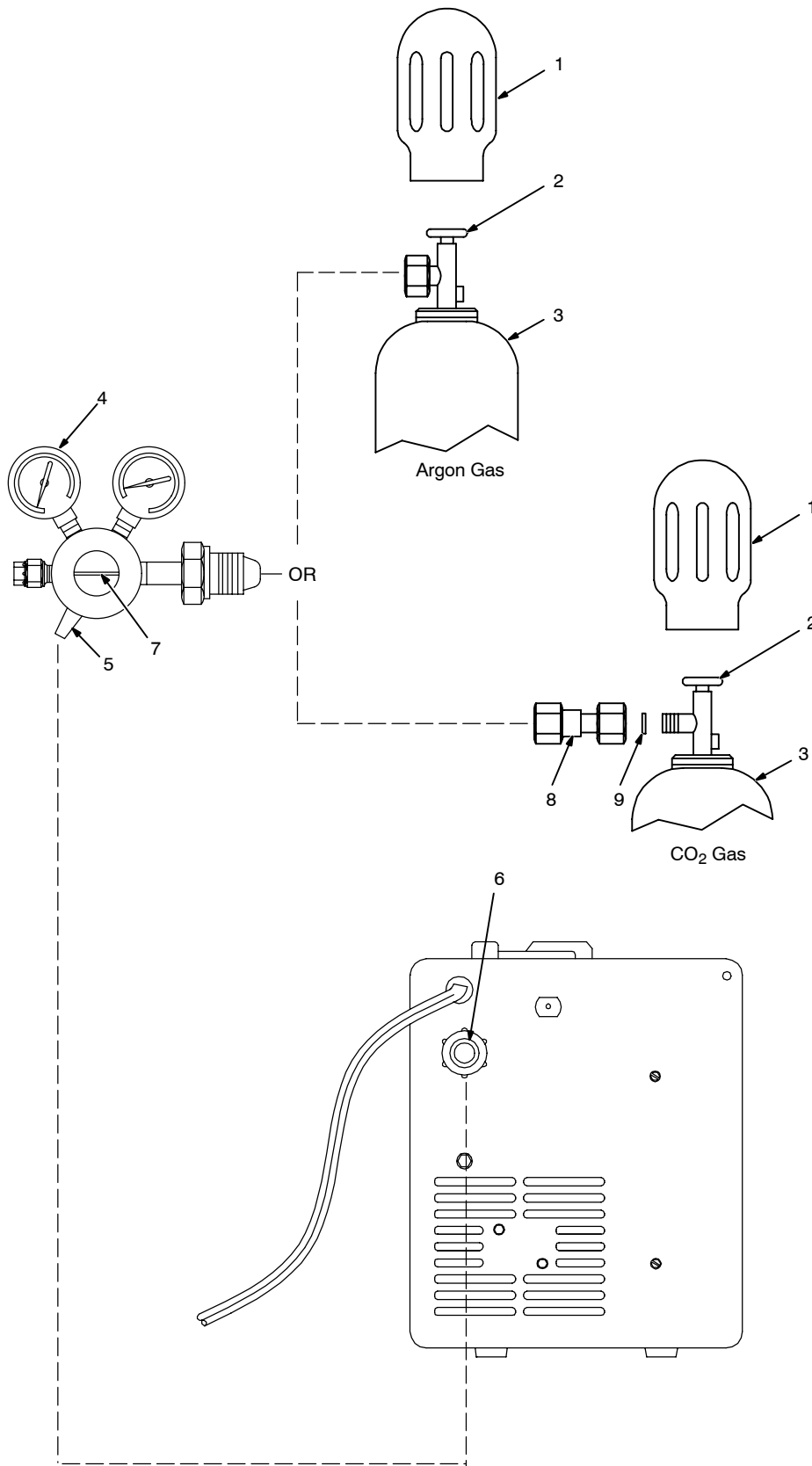

Obtain gas cylinder and chain to running gear, wall, or other stationary support so cylinder cannot fall and break off valve.

- 1 Cap
- 2 Cylinder Valve

Remove cap, stand to side of valve, and open valve slightly. Gas flow blows dust and dirt from valve. Close valve.

- 3 Cylinder
- 4 Regulator/Flowmeter

Install so face is vertical.

- 5 Regulator/Flowmeter Gas Hose Connection
- 6 Welding Power Source Gas Hose Connection

Connect customer supplied gas hose between regulator/flowmeter gas hose connection, and fitting on rear of welding power source.

- 7 Flow Adjust

Typical flow rate is 20 cfh (cubic feet per hour). Check wire manufacturer's recommended flow rate.

- 8 CO₂ Adapter (Customer Supplied)
 - 9 O-Ring (Customer Supplied)
- Install adapter with O-ring between regulator/flowmeter and CO₂ cylinder.

3-6. Selecting A Location And Connecting Input Power For 115 VAC Model

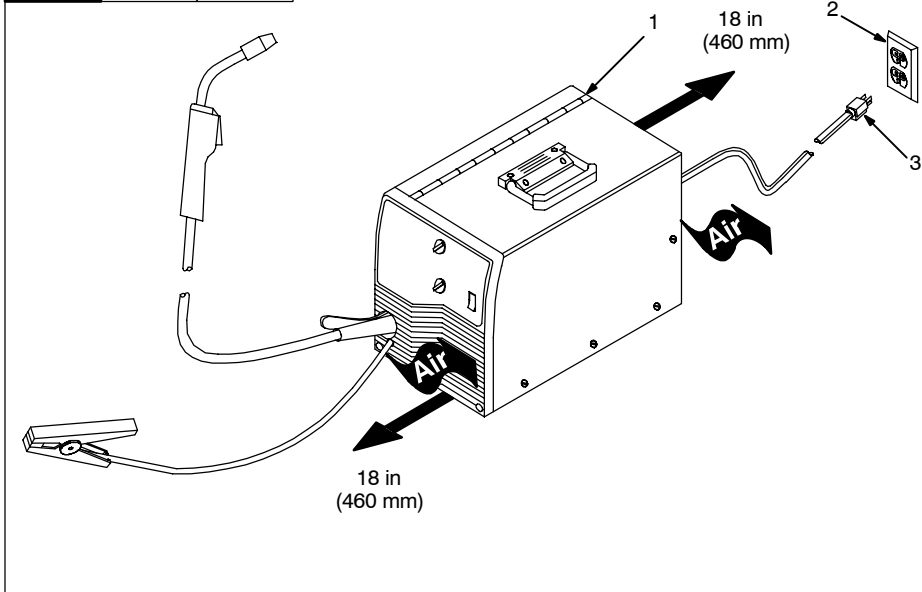

- 1 Rating Label
- 2 Grounded Receptacle

A 115 volt, 20 ampere individual branch circuit protected by time-delay fuses or circuit breaker is required.

- 3 Plug From Unit

Select extension cord of 14 AWG for up to 50 ft (15 m) or 12 AWG for 50 up to 200 ft (61 m).

▲ **Special installation may be required where gasoline or volatile liquids are present – see NEC Article 511 or CEC Section 20.**

802 442

3-7. Selecting A Location And Connecting Input Power For 230 VAC Model

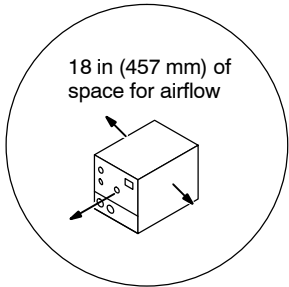

▲ Always connect grounding conductor first.

⊕ = GND/PE

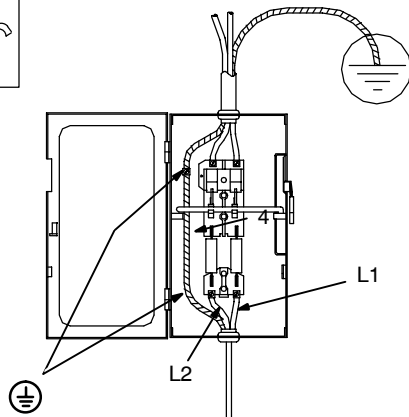

1 Rating Label
Supply correct input power.

2 Plug

3 Receptacle

Connect plug to receptacle.

4 Line Disconnect Device

See Section 3-8.

▲ Special installation may be required where gasoline or volatile liquids are present – see NEC Article 511 or CEC Section 20.

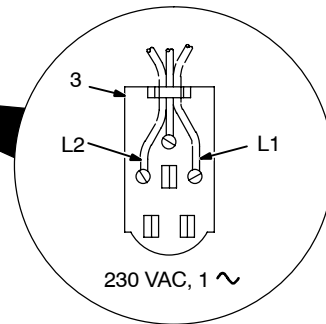
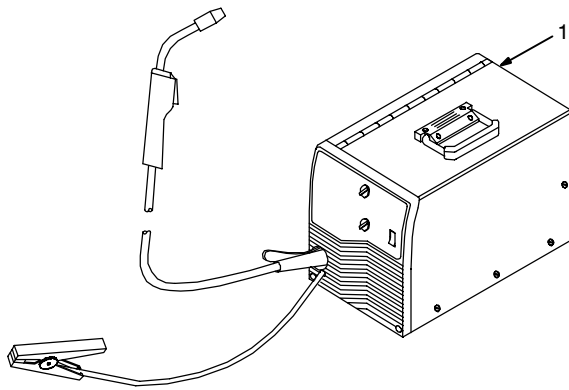

▲ Do not move or operate unit where it could tip.

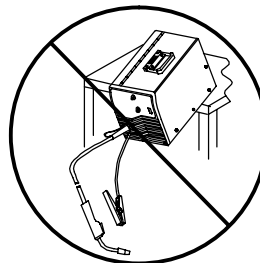

ssb2.2* 1/94 – 802 443 / Ref. 802 085

3-8. Electrical Service Guide For 230 VAC Model

Input Voltage	230
Input Amperes At Rated Output	20
Max Recommended Standard Fuse Or Circuit Breaker Rating In Amperes	20
Min Input Conductor Size In AWG/Kcmil	14
Max Recommended Input Conductor Length In Feet (Meters)	66 (20)
Min Grounding Conductor Size In AWG/Kcmil	12
Reference: 1996 National Electrical Code (NEC)	S-0092-J

3-9. Installing Wire Spool And Adjusting Hub Tension

Standard Wire Spool (8 in)

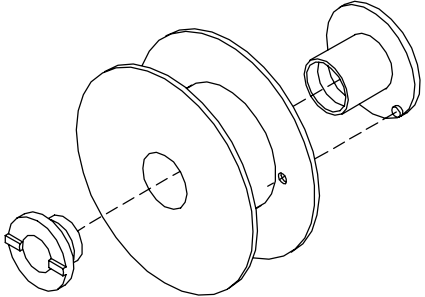

1 Lb Wire Spool (4 in)

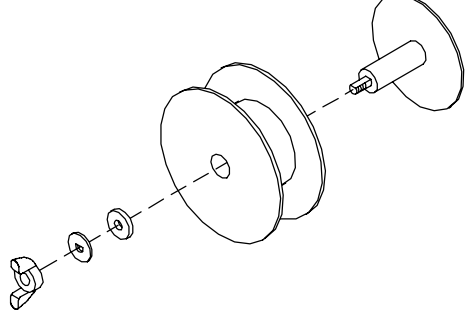

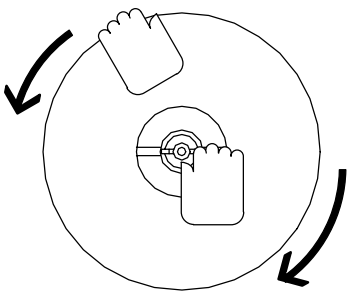

Install spool so welding wire feeds from bottom.

Adjusting Hub Tension



Turn wingnut. When a slight force is needed to turn spool, tension is set.

Tools Needed:

15/16 in

S-0499

3-10. Threading Welding Wire



- 1 Wire Spool
 - 2 Welding Wire
 - 3 Inlet Wire Guide
 - 4 Pressure Adjustment Knob
 - 5 Drive Roll
 - 6 Gun Conduit Cable
- Lay gun cable out straight.

Tools Needed:

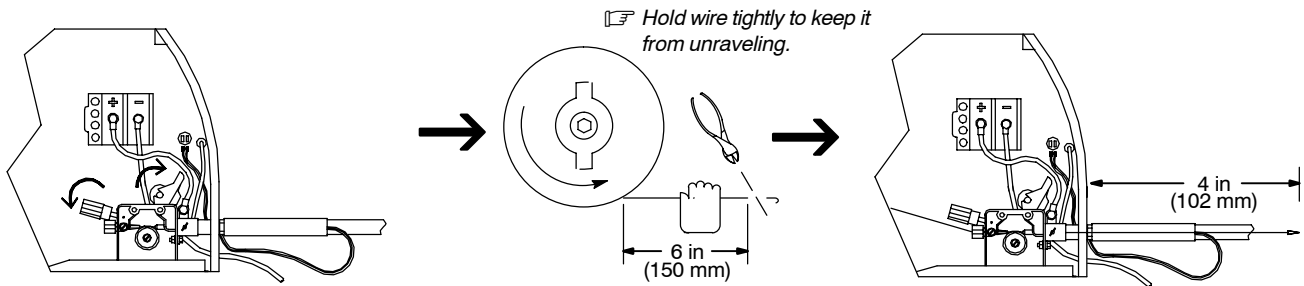
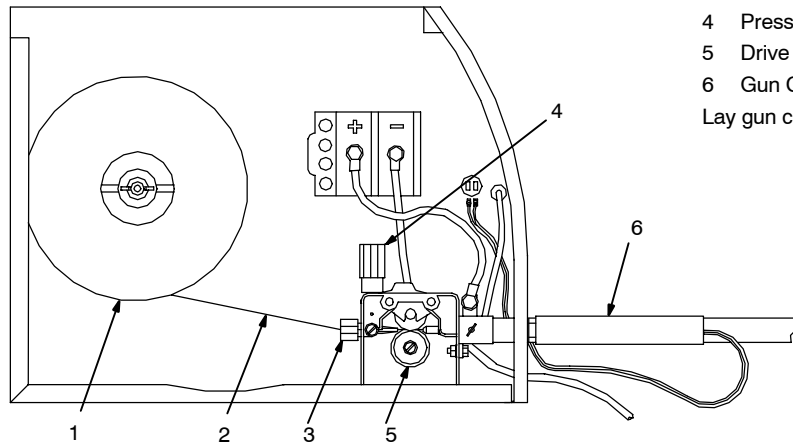
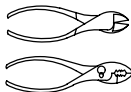

Open pressure assembly.

Pull and hold wire; cut off end.

Push wire thru guides into gun; continue to hold wire.

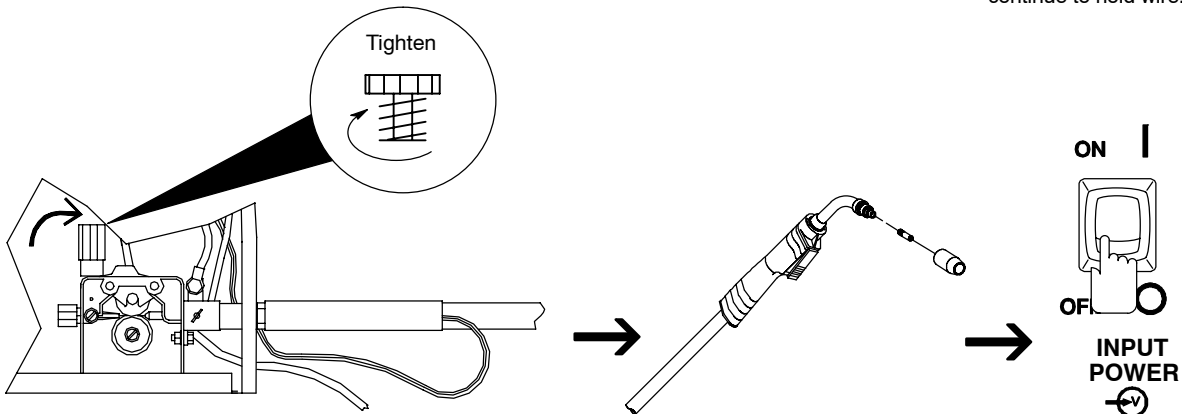

Close and tighten pressure assembly, and let go of wire.

Remove gun nozzle and contact tip.

Turn power on.

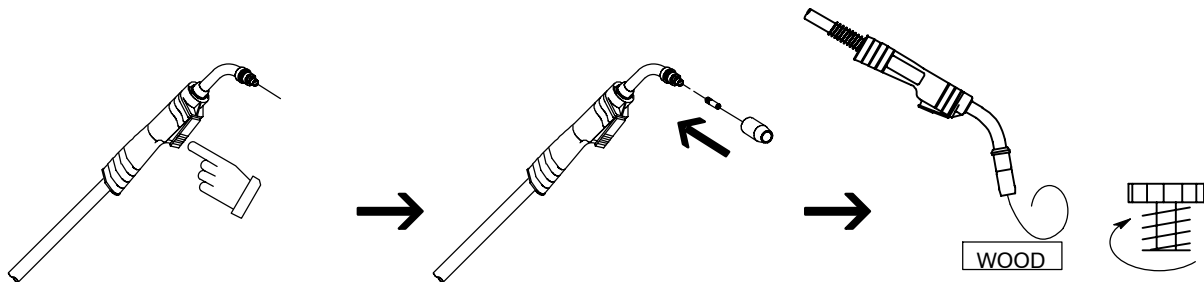

Press gun trigger until wire comes out of gun.

Reinstall contact tip and nozzle.

Feed wire to check drive roll pressure. Tighten knob enough to prevent slipping. Cut off wire. Close door.

SECTION 4 – OPERATION

4-1. Controls



1 Voltage Switch

The higher the selected number, the thicker the material that can be welded (see weld setting label in welding power source or Sections 4-2 and 4-3, as applicable). Do not switch under load.

2 Voltage Switch - Purge "0" Position

In purge position, fan runs but there is no weld output.

3 Wire Speed Control

Use control to select a wire feed speed. As Voltage switch setting increases, wire speed range also increases (see weld setting label in welding power source or Sections 4-2 or 4-3, as applicable).

4 Power Switch

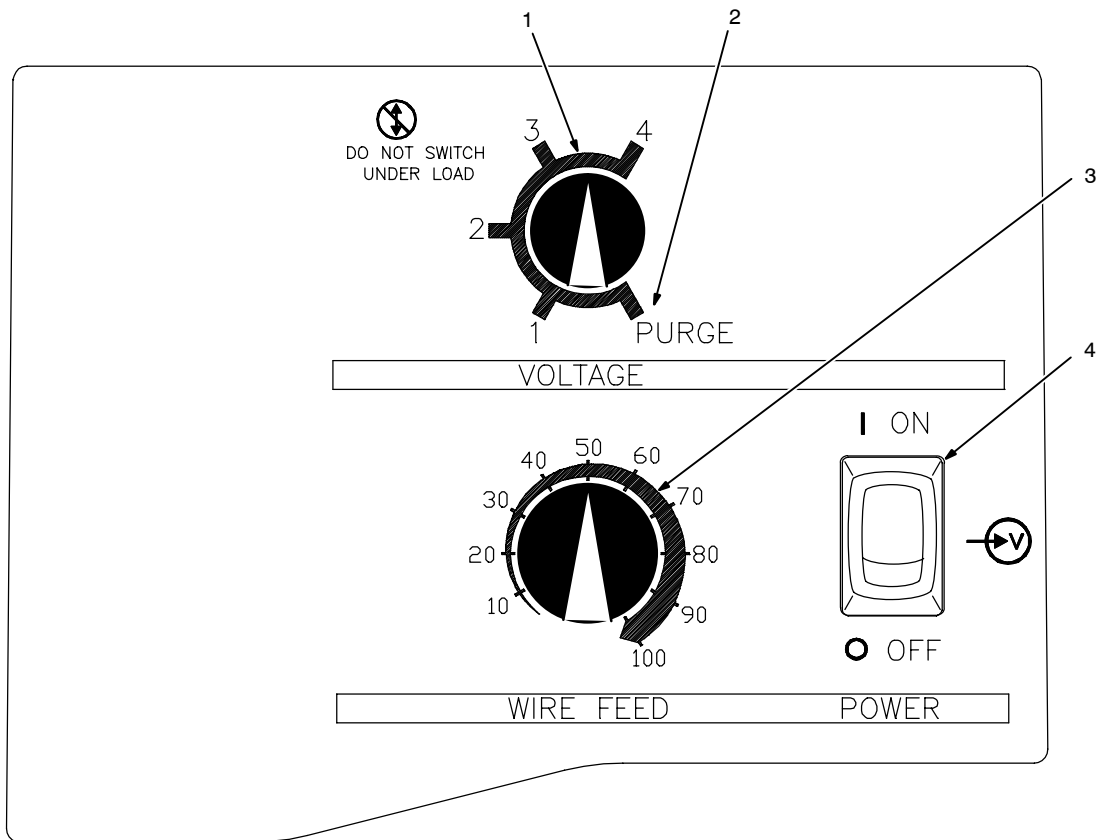

4-2. Weld Parameters For 115 VAC Model

196052

Welding Guide *Settings are approximate. Adjust as required.*

TO WELD:	THICKNESS (Inches/ Gauge)	WIRE TYPE\SIZE	GAS	GAS FLOW (Cubic Ft/Hr)	POLARITY	VOLTAGE		WIRE FEED SPEED		WIRE STICKOUT (Inches)
						CO ₂	C ₂₅	CO ₂	C ₂₅	
Auto Body	.022" 24 GA.	ER70S-6 (.024)	CO ₂ or C ₂₅	20	DCEP	1	1	1	10	1/4
Lawnmower Handles, Wagons, Tricycles, Duct Work, Auto Door Brackets, Tailpipes, Bicycles	3/64" 18 GA.	ER70S-6 (.024)	CO ₂ or C ₂₅	20	DCEP	2	1	10	20	1/4
		ER70S-6 (.030)	CO ₂ or C ₂₅	20	DCEP	3	2	1	10	5/16
		E71T-11 (.030)	—	—	DCEN	1		1		1/4
Wheelbarrows, Lawnmower Decks, Basketball Posts, Galvanized Roofing, Trailer Sides, Garage Door Tracks, Tailpipes, Motorcycles	1/16" 16 GA.	ER70S-6 (.024)	CO ₂ or C ₂₅	20	DCEP	2	2	15	30	5/16
		ER70S-6 (.030)	CO ₂ or C ₂₅	20	DCEP	4	3	1	20	5/16
		ER70S-6 (.035)	CO ₂ or C ₂₅	20	DCEP	-	2	-	10	5/16
		E71T-11 (.030)	—	—	DCEN	1		1		1/4
		E71T-11 (.045)	—	—	DCEN	N/A		N/A		1/2
Fencing, Lawnmower Decks, Trailers, Trailer Frames, Wheelbarrows, Garage Door Brackets, Grain Wagons, Bailers, Combines, Bumpers	1/8" 11 GA.	ER70S-6 (.024)	CO ₂ or C ₂₅	20	DCEP	4	4	40	65	5/16
		ER70S-6 (.030)	CO ₂ or C ₂₅	20	DCEP	4	4	20	40	1/2
		ER70S-6 (.035)	CO ₂ or C ₂₅	20	DCEP	-	4	-	20	1/2
		E71T-11 (.030)	—	—	DCEN	3		10		1/4
		E71T-11 (.045)	—	—	DCEN	4		20		3/4
Trailer Hitches, Door Hinge Brackets, Axles, "A" Frames, Farm Equipment Frames, Basketball Rims and Brackets	3/16" 7 GA.	ER70S-6 (.030)	CO ₂ or C ₂₅	20	DCEP	-	4	-	55	1/2
		ER70S-6 (.035)	CO ₂ or C ₂₅	20	DCEP	-	4	-	20	1/2
		E71T-11 (.030)	—	—	DCEN	4		20		1/2
		E71T-11 (.035)	—	—	DCEN	4		10		1/2
		E71T-11 (.045)	—	—	DCEN	3		30		3/4
Stainless Steel Fryers, Counter Tops, Kitchen Equipment	1/16" 16 GA.	Solid Stainless (.030)	Tri-mix	20	DCEP	3		10		5/16
	1/8" 11 GA.		Tri-mix	20	DCEP	4		30		1/2
Aluminum	1/8" 11 GA.	4043 (.030)	ARGON	20	DCEP	4		90		1/4

CO₂ = Carbon Dioxide

C₂₅ = Argon + 25% Carbon Dioxide

Tri-mix = 90% Helium + 7.5% Argon +
2.5% Carbon Dioxide

Drive Tension Settings

.024 wire set at 3 .035 alum. wire set at 2

.030 wire set at 2.5 .045 wire set at 1.5

.035 wire set at 2

196 052

4-3. Weld Parameters For 230 VAC Model

196081

Welding Guide *Settings are approximate. Adjust as required.*

TO WELD:	THICKNESS (Inches/ Gauge)	WIRE TYPE\SIZE	GAS	GAS FLOW (Cubic Ft/Hr)	POLARITY	VOLTAGE		WIRE FEED SPEED		WIRE STICKOUT (Inches)
						CO ₂	C 25	CO ₂	C 25	
Auto Body	.022" 24 GA.	ER70S-6 (.024)	CO ₂ or C ₂₅	20	DCEP	1	1	20	20	1/4
Lawnmower Handles, Wagons, Tricycles, Duct Work, Auto Door Brackets, Tailpipes, Bicycles	3/64" 18 GA.	ER70S-6 (.024)	CO ₂ or C ₂₅	20	DCEP	2	1	30	45	1/4
		ER70S-6 (.030)	CO ₂ or C ₂₅	20	DCEP	2	1	1	20	5/16
		ER70S-6 (.035)	CO ₂ or C ₂₅	20	DCEP	2	1	1	20	5/16
Wheelbarrows, Lawnmower Decks, Basketball Posts, Galvanized Roofing, Trailer Sides, Garage Door Tracks, Tailpipes, Motorcycles	1/16" 16 GA.	ER70S-6 (.024)	CO ₂ or C ₂₅	20	DCEP	2	2	35	85	5/16
		ER70S-6 (.030)	CO ₂ or C ₂₅	20	DCEP	2	2	20	40	5/16
		ER70S-6 (.035)	CO ₂ or C ₂₅	20	DCEP	2	2	10	30	5/16
		E71T-11 (.030)	—	—	DCEN	1	10	1/4		
		E71T-11 (.035)	—	—	DCEN	1	1	1/4		
Fencing, Lawnmower Decks, Trailers, Trailer Frames, Wheelbarrows, Garage Door Brackets, Grain Wagons, Bailers, Combines, Bumpers	1/8" 11 GA.	ER70S-6 (.024)	CO ₂ or C ₂₅	20	DCEP	3	3	78	90	5/16
		ER70S-6 (.030)	CO ₂ or C ₂₅	20	DCEP	3	3	35	80	1/2
		ER70S-6 (.035)	CO ₂ or C ₂₅	20	DCEP	3	3	55	75	1/2
		E71T-11 (.030)	—	—	DCEN	3	40	1/4		
		E71T-11 (.045)	—	—	DCEN	2	20	3/4		
Trailer Hitches, Door Hinge Brackets, Axles, "A" Frames, Farm Equipment Frames, Basketball Rims and Brackets	3/16" 7 GA.	ER70S-6 (.024)	CO ₂ or C ₂₅	20	DCEP	4	4	85	100	1/2
		ER70S-6 (.030)	CO ₂ or C ₂₅	20	DCEP	3	4	65	85	1/2
		ER70S-6 (.035)	CO ₂ or C ₂₅	20	DCEP	3	3	65	80	1/2
		E71T-11 (.030)	—	—	DCEN	3	52	1/2		
		E71T-11 (.045)	—	—	DCEN	3	40	3/4		
Stainless Steel Fryers, Counter Tops, Kitchen Equipment	1/16" 16 GA.	Solid Stainless (.030)	Tri-mix	20	DCEP	2	20	5/16		
	1/8" 11 GA.		Tri-mix	20	DCEP	2	40	1/2		
Aluminum	1/16" 16 GA.	5356 (.035)	ARGON	20	DCEP	1	95	1/4		

CO₂ = Carbon Dioxide

C₂₅ = Argon + 25% Carbon Dioxide

Tri-mix = 90% Helium + 7.5% Argon +
2.5% Carbon Dioxide

Drive Tension Settings

.024 wire set at 3 .035 alum. wire set at 2













.030 wire set at 2.5 .045 wire set at 1.5

.035 wire set at 2

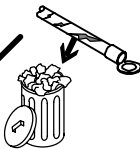

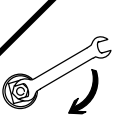
196 081-A

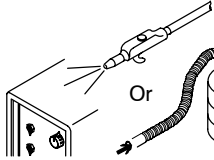
SECTION 5 – MAINTENANCE & TROUBLESHOOTING

5-1. Routine Maintenance

			▲ Disconnect power before maintaining.
	3 Months		
Replace unreadable labels.			Repair or replace cracked weld cable.
			Clean and tighten weld terminals.
			
	6 Months		
Blow out or vacuum inside. During heavy service, clean monthly.		Or	

5-2. Overload Protection

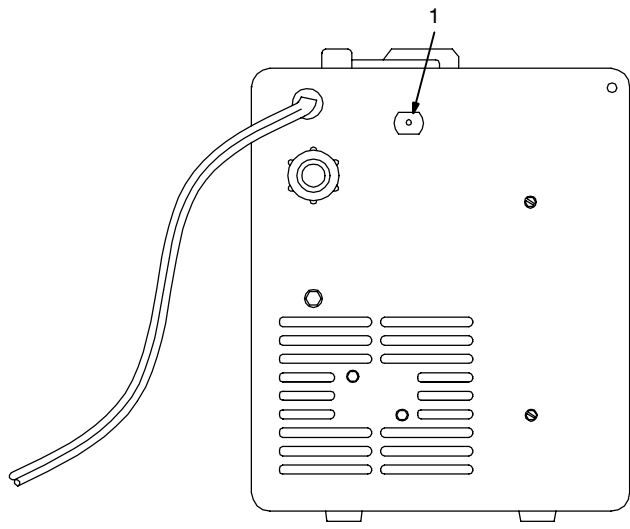
		<p>1 Circuit Breaker CB1 CB1 protects unit from overload. If CB1 opens, unit shuts down. Reset breaker.</p>
		

802 441

5-3. Drive Motor Protection

Drive motor protection circuit protects drive motor from overload. If drive motor becomes inoperative, release gun trigger and wait until protection circuit resets allowing drive motor to feed wire again.

5-4. Changing Drive Roll Or Wire Inlet Guide

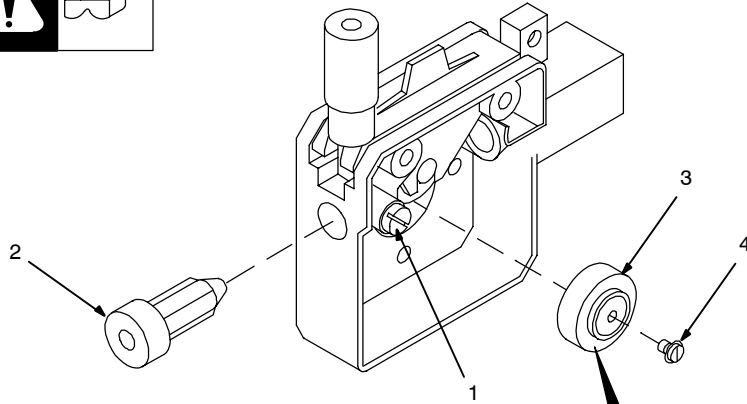

Tools Needed:

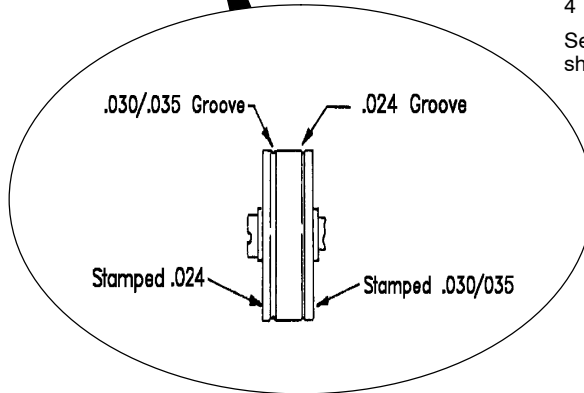
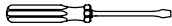

- 1 Inlet Wire Guide Securing Screw
- 2 Inlet Wire Guide

Loosen screw. Slide tip as close to drive rolls as possible without touching. Tighten screw.

- 3 Drive Roll

The drive roll consists of two different sized grooves. The stamped markings on the end surface of the drive roll refers to the groove on the opposite side of the drive roll. The groove closest to the motor shaft is the proper groove to thread (see Section 3-10). **NOTE: when changing drive rolls, make sure the woodruff key is on the motor shaft, and not in the old drive roll.**

- 4 Drive Roll Securing Screw

Secure drive roll with screw as shown.

Ref. 802 444 / 802 139

5-5. Replacing Gun Contact Tip

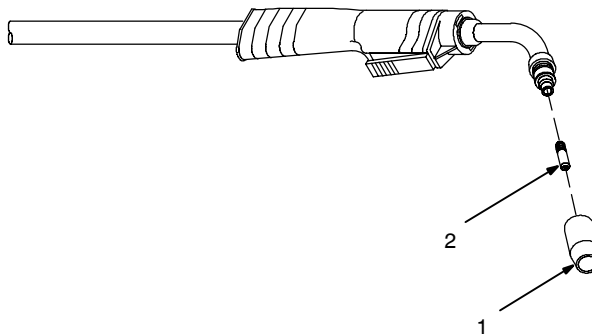

Tools Needed:

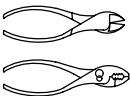

▲ **Turn Off power before replacing contact tip.**

- 1 Nozzle
- 2 Contact Tip

Cut off welding wire at contact tip. Remove nozzle.

Remove contact tip and install new contact tip. Reinstall nozzle.

Ref. 802 399-A

5-6. Cleaning Or Replacing Gun Liner

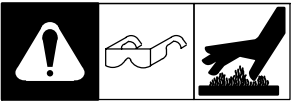

▲ Disconnect gun from unit.

Tools Needed:

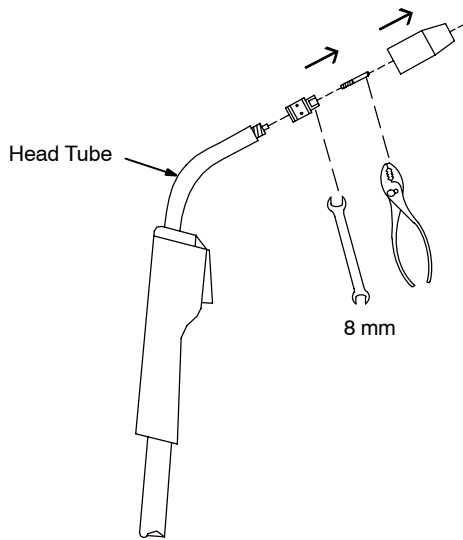
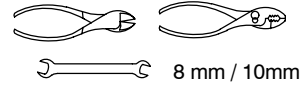

Remove nozzle, contact tip, adapter, gas diffuser, and wire outlet guide.

8 mm

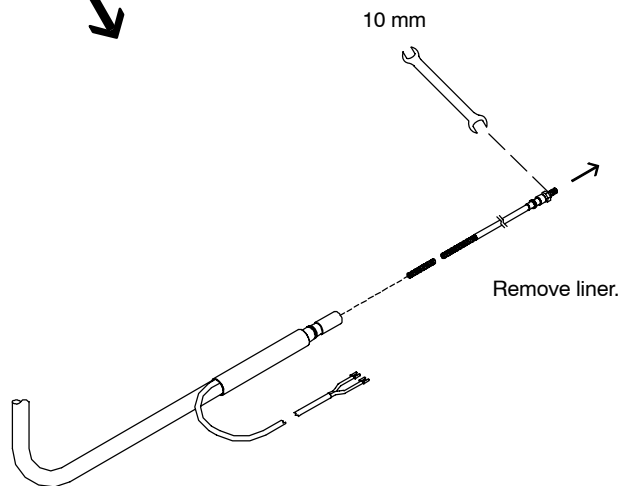

10 mm

Remove liner.

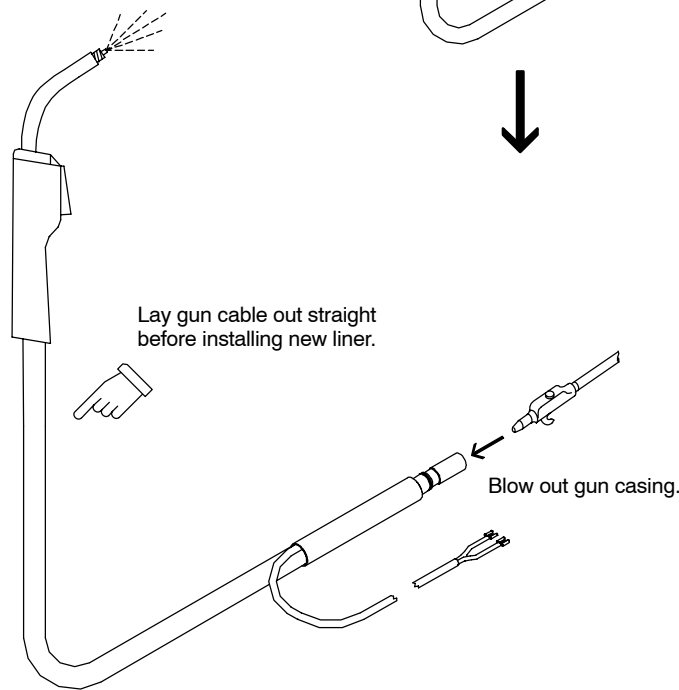

Lay gun cable out straight before installing new liner.

Blow out gun casing.

To Reassemble Gun:

Insert new liner.

Install wire outlet guide so that 1/8 in (3 mm) of liner sticks out. Hand tighten outlet guide, and then tighten two full turns more.

Cut liner off so that 3/4 in (19 mm) sticks out of head tube.

Install gas diffuser, adapter, contact tip, and nozzle.

Ref. 802 446

5-7. Replacing Switch And/Or Head Tube

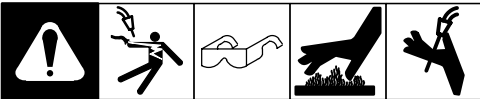

▲ Turn Off welding power source /wire feeder and disconnect gun.

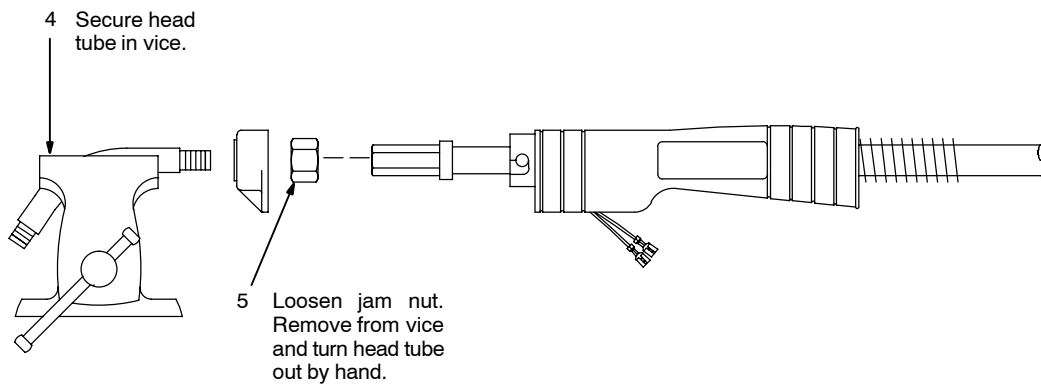
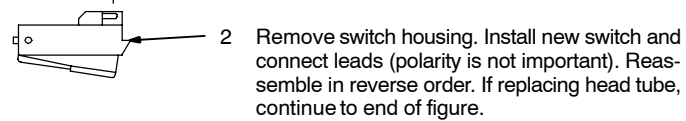
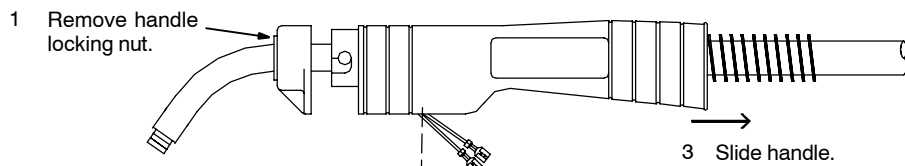

6 Hand-tighten head tube into cable connector.

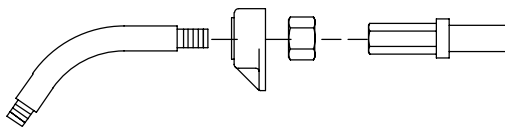

7 Place head tube in vice and tighten until nuts are tight.

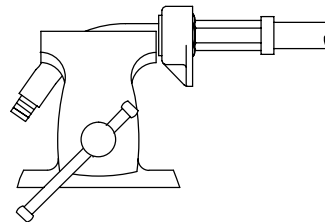

8 Remove from vice. Reposition handle and install switch housing. Secure with handle locking nut.

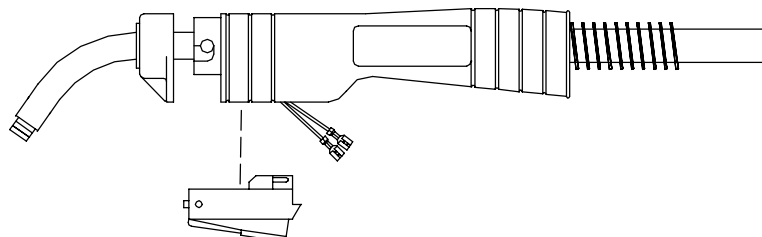

Tools Needed:



19 mm

Ref. ST-800 795-C

5-8. Troubleshooting Table

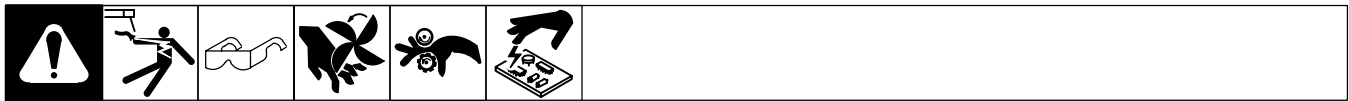

Trouble	Remedy
No weld output; wire does not feed; fan does not run.	Secure power cord plug in receptacle (see Section 3-6).
	Replace building line fuse or reset circuit breaker if open.
	Place Power switch in On position (see Section 4-1).
	Reset welding power source circuit breaker if open.
No weld output; wire does not feed; fan motor continues to run.	Thermostat TP1 open (overheating). Allow fan to run with gun trigger switch off; thermostat closes when unit has cooled (see Section 2-2).
	Secure gun trigger leads (see Section 3-1).
No weld output; wire feeds.	Connect work clamp to get good metal to metal contact.
	Replace contact tip (see Section 5-5).
	Check for proper polarity connections (see Section 3-4).
	Check thumbscrew securing gun end to feed head adapter and tighten if necessary.
Low weld output.	Connect unit to proper input voltage or check for low line voltage.
	Place voltage switch in desired position (see Section 4-1).
Electrode wire feeding stops during welding.	Straighten gun cable and/or replace damaged parts.
	Adjust drive roll pressure (see Section 3-10).
	Change to proper drive roll groove (see Section 5-4).
	Readjust hub tension (see Section 3-9).
	Replace contact tip if blocked (see Section 5-5).
	Clean or replace wire inlet guide or liner if dirty or plugged (see Section 5-4 or Section 5-6).
	Replace drive roll or pressure bearing if worn or slipping (see Section 5-4).
	Secure gun trigger leads or repair leads (see Section 3-1).
	Check and clear any restrictions at drive assembly and liner (see Section 3-10 or Section 5-6).
	Release gun trigger and allow gun and motor protection circuitry to reset.
Have nearest Factory Authorized Service Agent check drive motor.	

SECTION 6 – ELECTRICAL DIAGRAM

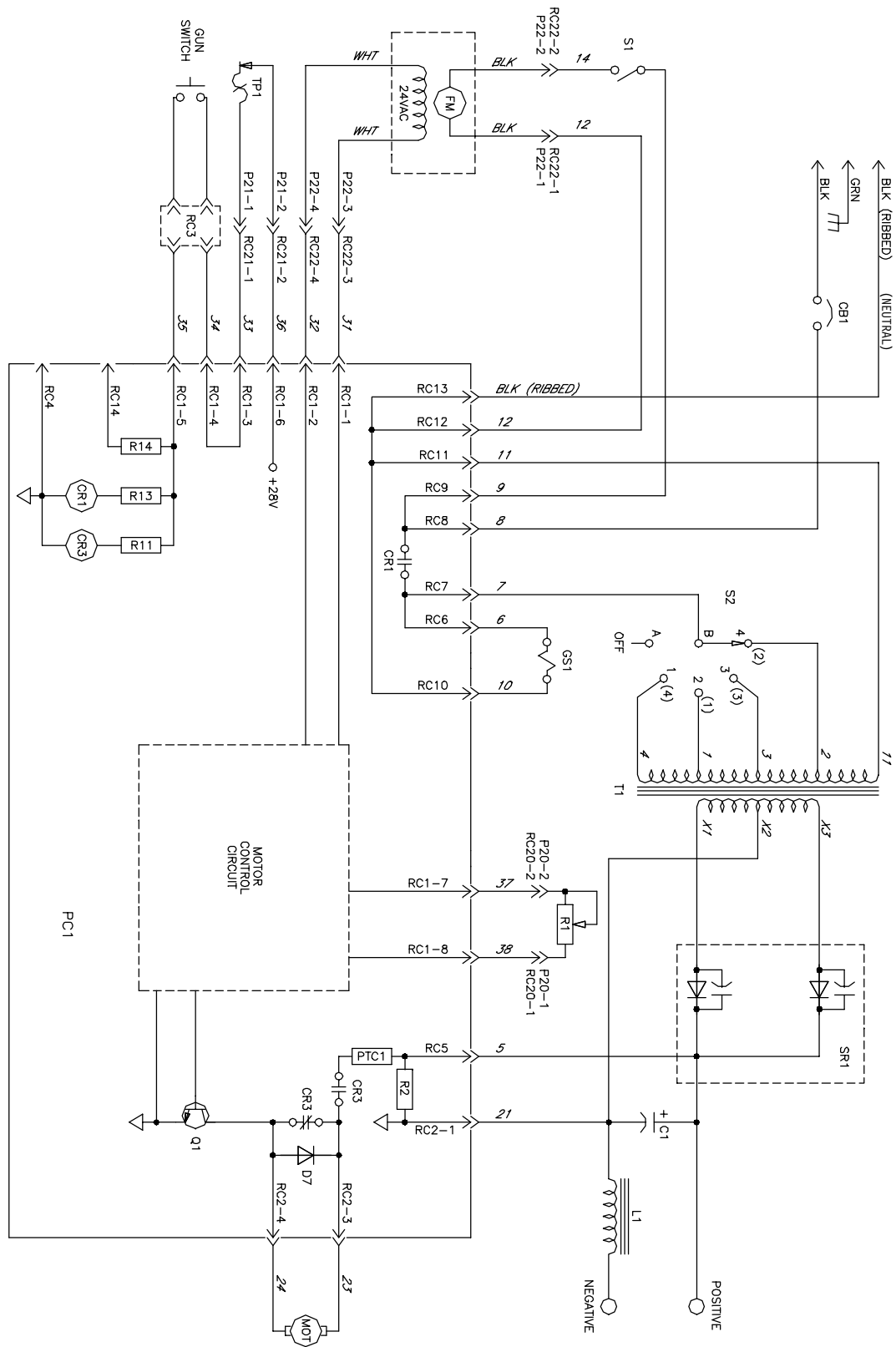

Figure 6-1. Circuit Diagram For 115 VAC Model

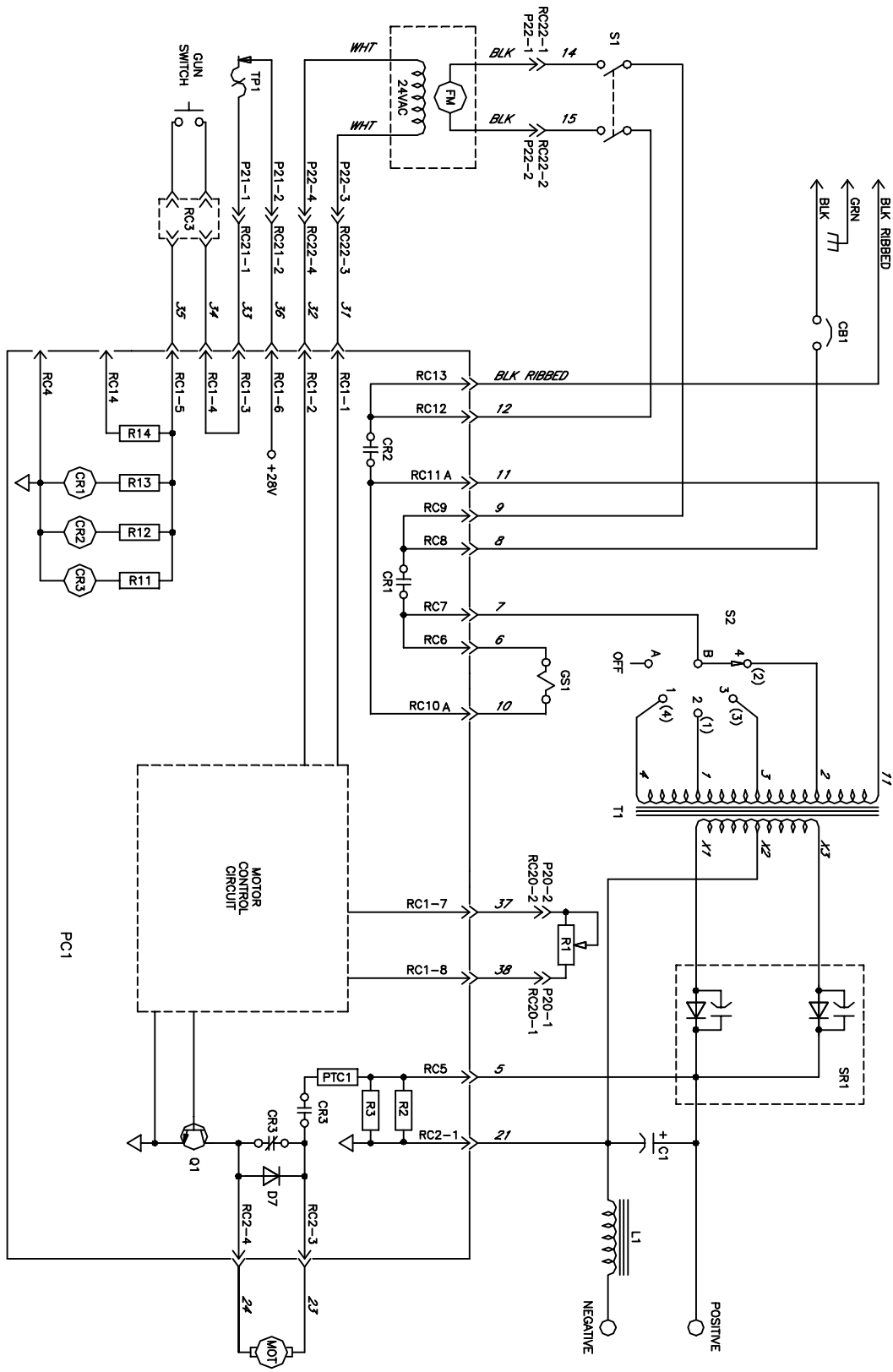
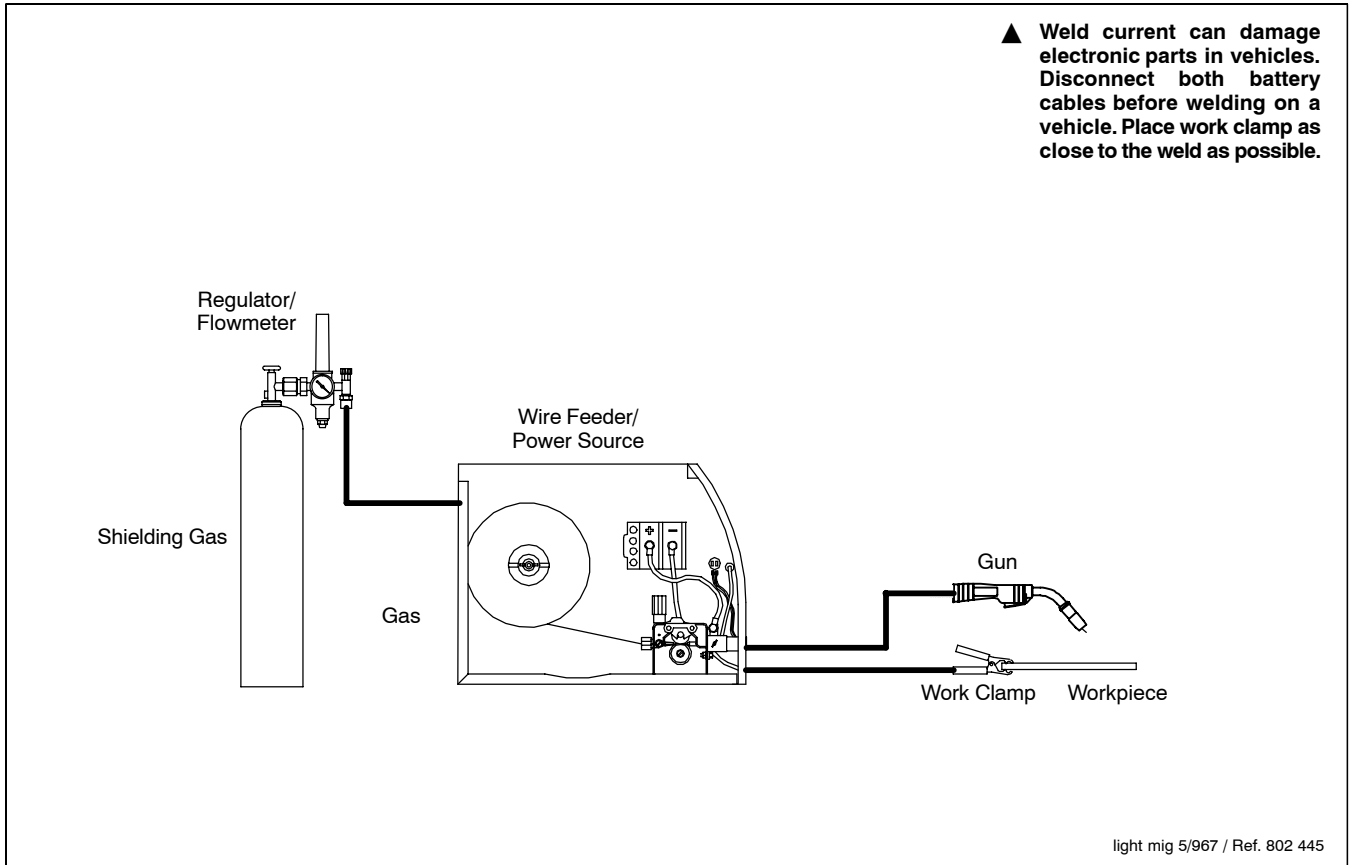

Figure 6-2. Circuit Diagram For 230 VAC Model

SECTION 7 – MIG WELDING (GMAW) GUIDELINES

7-1. Typical MIG Process Connections



7-2. Typical MIG Process Control Settings

NOTE

These settings are guidelines only. Material and wire type, joint design, fitup, position, shielding gas, etc. affect settings. Test welds to be sure they comply to specifications.

Material thickness determines weld parameters.

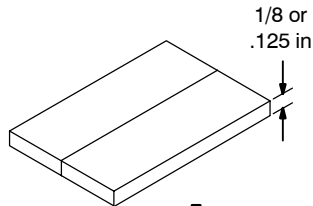

Convert Material Thickness to Amperage (A)

(.001 in = 1 ampere)
.125 in = 125 A

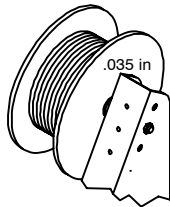

Wire Size	Amperage Range
.023 in	30 – 90 A
.030 in	40 – 145 A
.035 in	50 – 180 A

Select Wire Size

Wire Size	Recommendation	Wire Speed (Approx.)
.023 in	3.5 in per ampere	3.5 x 125 A = 437 ipm
.030 in	2 in per ampere	2 x 125 A = 250 ipm
.035 in	1.6 in per ampere	1.6 x 125 A = 200 ipm

Select Wire Speed (Amperage)

125 A based on 1/8 in material thickness

ipm = inch per minute

Low voltage: wire stubs into work
High voltage: arc is unstable (spatter)
Set voltage midway between high/low voltage.

Select Voltage

Voltage controls height and width of weld bead.

Wire speed (amperage) controls weld penetration (wire speed = burn-off rate)

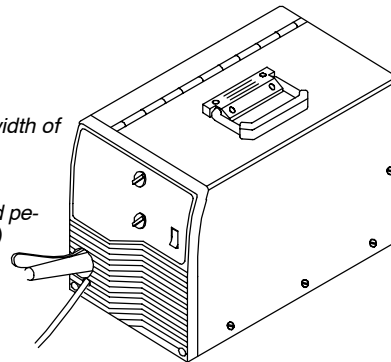

7-3. Holding And Positioning Welding Gun

NOTE

Welding wire is energized when gun trigger is pressed. Before lowering helmet and pressing trigger, be sure wire is no more than 1/2 in (13 mm) past end of nozzle, and tip of wire is positioned correctly on seam.

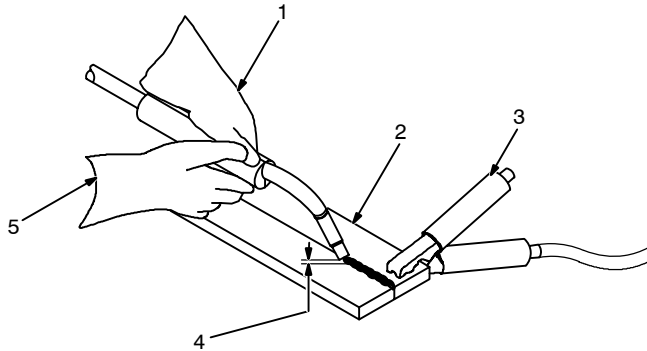

- 1 Hold Gun and Control Gun Trigger
- 2 Workpiece
- 3 Work Clamp
- 4 Electrode Extension (Stickout) 1/4 to 1/2 in (6 To 13 mm)
- 5 Cradle Gun and Rest Hand on Workpiece

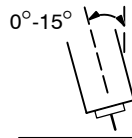
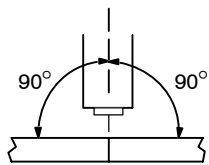

End View Of Work Angle

Side View Of Gun Angle

GROOVE WELDS

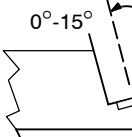
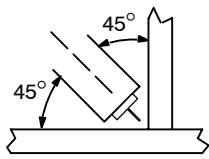

End View Of Work Angle

Side View Of Gun Angle

FILLET WELDS

S-0421-A

7-4. Conditions That Affect Weld Bead Shape

NOTE

Weld bead shape depends on gun angle, direction of travel, electrode extension (stickout), travel speed, thickness of base metal, wire feed speed (weld current), and voltage.

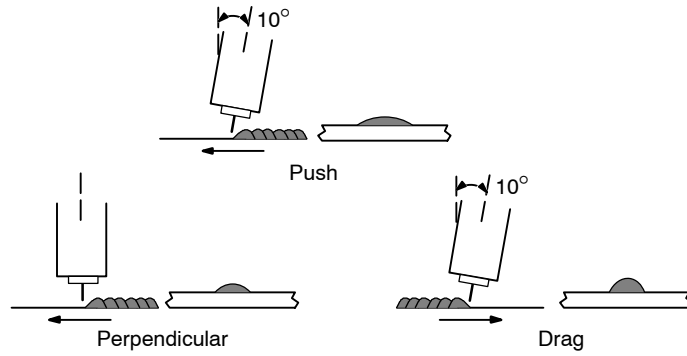

GUN ANGLES AND WELD BEAD PROFILES

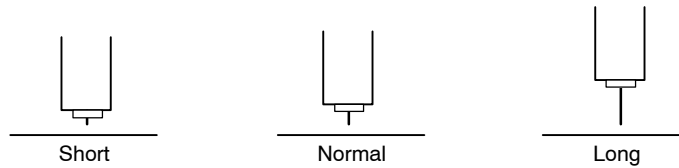

ELECTRODE EXTENSIONS (STICKOUT)

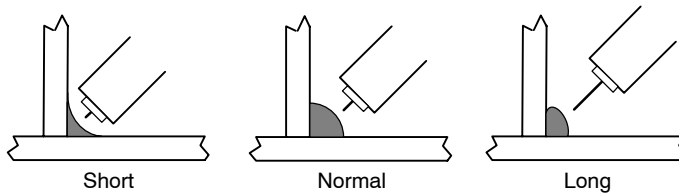

FILLET WELD ELECTRODE EXTENSIONS (STICKOUT)

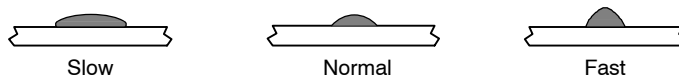

GUN TRAVEL SPEED

S-0634

7-5. Gun Movement During Welding

NOTE

Normally, a single stringer bead is satisfactory for most narrow groove weld joints; however, for wide groove weld joints or bridging across gaps, a weave bead or multiple stringer beads works better.

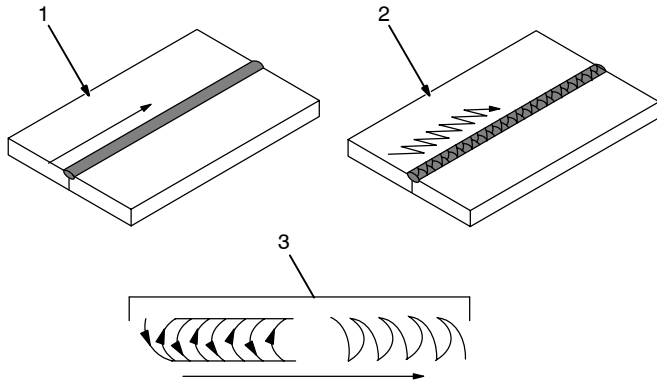

- 1 Stringer Bead – Steady Movement Along Seam
- 2 Weave Bead – Side To Side Movement Along Seam
- 3 Weave Patterns

Use weave patterns to cover a wide area in one pass of the electrode.

S-0054-A

7-6. Poor Weld Bead Characteristics

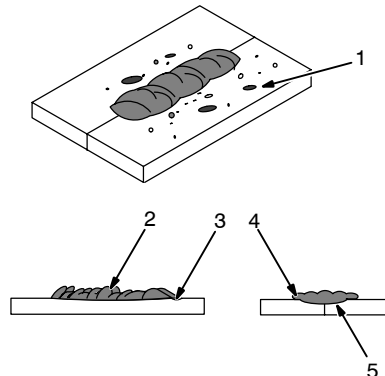

- 1 Large Spatter Deposits
- 2 Rough, Uneven Bead
- 3 Slight Crater During Welding
- 4 Bad Overlap
- 5 Poor Penetration

S-0053-A

7-7. Good Weld Bead Characteristics

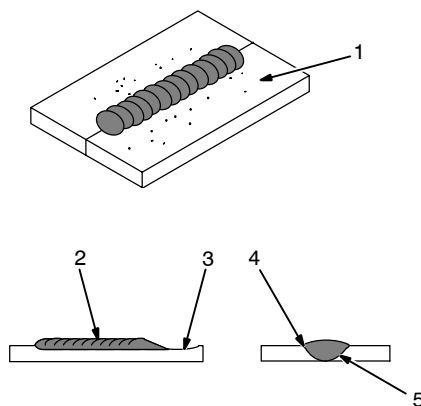

- 1 Fine Spatter
- 2 Uniform Bead
- 3 Moderate Crater During Welding

Weld a new bead or layer for each 1/8 in (3.2 mm) thickness in metals being welded.

- 4 No Overlap
- 5 Good Penetration into Base Metal

S-0052-B

7-8. Troubleshooting – Excessive Spatter

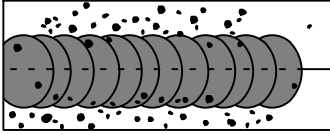

Excessive Spatter – scattering of molten metal particles that cool to solid form near weld bead.

S-0636

Possible Causes	Corrective Actions
Wire feed speed too high.	Select lower wire feed speed.
Voltage too high.	Select lower voltage range.
Electrode extension (stickout) too long.	Use shorter electrode extension (stickout).
Workpiece dirty.	Remove all grease, oil, moisture, rust, paint, undercoating, and dirt from work surface before welding.
Insufficient shielding gas at welding arc.	Increase flow of shielding gas at regulator/flowmeter and/or prevent drafts near welding arc.
Dirty welding wire.	Use clean, dry welding wire.
	Eliminate pickup of oil or lubricant on welding wire from feeder or liner.

7-9. Troubleshooting – Porosity

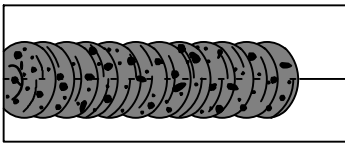

Porosity – small cavities or holes resulting from gas pockets in weld metal.

S-0635

Possible Causes	Corrective Actions
Insufficient shielding gas at welding arc.	Increase flow of shielding gas at regulator/flowmeter and/or prevent drafts near welding arc.
	Remove spatter from gun nozzle.
	Check gas hoses for leaks.
	Place nozzle 1/4 to 1/2 in (6-13 mm) from workpiece.
	Hold gun near bead at end of weld until molten metal solidifies.
Wrong gas.	Use welding grade shielding gas; change to different gas.
Dirty welding wire.	Use clean, dry welding wire.
	Eliminate pick up of oil or lubricant on welding wire from feeder or liner.
Workpiece dirty.	Remove all grease, oil, moisture, rust, paint, coatings, and dirt from work surface before welding.
	Use a more highly deoxidizing welding wire (contact supplier).
Welding wire extends too far out of nozzle.	Be sure welding wire extends not more than 1/2 in (13 mm) beyond nozzle.

7-10. Troubleshooting – Excessive Penetration

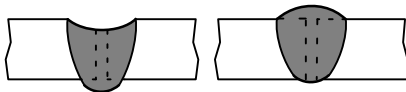

Excessive Penetration Good Penetration

Excessive Penetration – weld metal melting through base metal and hanging underneath weld.

S-0639

Possible Causes	Corrective Actions
Excessive heat input.	Select lower voltage range and reduce wire feed speed.
	Increase travel speed.

7-11. Troubleshooting – Lack Of Penetration

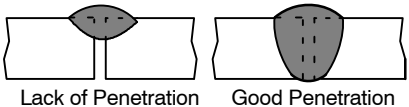
 <p>Lack of Penetration Good Penetration</p>		<p>Lack Of Penetration – shallow fusion between weld metal and base metal.</p>	S-0638
Possible Causes	Corrective Actions		
Improper joint preparation.	Material too thick. Joint preparation and design must provide access to bottom of groove while maintaining proper welding wire extension and arc characteristics.		
Improper weld technique.	Maintain normal gun angle of 0 to 15 degrees to achieve maximum penetration.		
	Keep arc on leading edge of weld puddle.		
	Be sure welding wire extends not more than 1/2 in (13 mm) beyond nozzle.		
Insufficient heat input.	Select higher wire feed speed and/or select higher voltage range.		
	Reduce travel speed.		

7-12. Troubleshooting – Incomplete Fusion

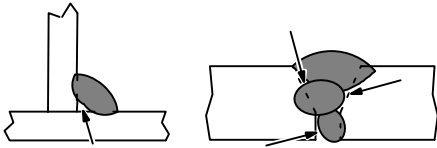
		<p>Incomplete Fusion – failure of weld metal to fuse completely with base metal or a preceding weld bead.</p>	S-0637
Possible Causes	Corrective Actions		
Workpiece dirty.	Remove all grease, oil, moisture, rust, paint, undercoating, and dirt from work surface before welding.		
Insufficient heat input.	Select higher voltage range and/or adjust wire feed speed.		
Improper welding technique.	Place stringer bead in proper location(s) at joint during welding.		
	Adjust work angle or widen groove to access bottom during welding.		
	Momentarily hold arc on groove side walls when using weaving technique.		
	Keep arc on leading edge of weld puddle.		
	Use correct gun angle of 0 to 15 degrees.		

7-13. Troubleshooting – Burn-Through

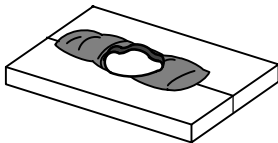
		<p>Burn-Through – weld metal melting completely through base metal resulting in holes where no metal remains.</p>	S-0640
Possible Causes	Corrective Actions		
Excessive heat input.	Select lower voltage range and reduce wire feed speed.		
	Increase and/or maintain steady travel speed.		

7-14. Troubleshooting – Waviness Of Bead

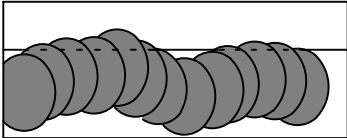
		<p>Waviness Of Bead – weld metal that is not parallel and does not cover joint formed by base metal.</p>	S-0641
Possible Causes	Corrective Actions		
Welding wire extends too far out of nozzle.	Be sure welding wire extends not more than 1/2 in (13 mm) beyond nozzle.		
Unsteady hand.	Support hand on solid surface or use two hands.		

7-15. Troubleshooting – Distortion

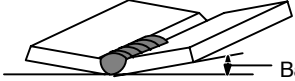
		<p>Distortion – contraction of weld metal during welding that forces base metal to move.</p>	S-0642
<p>Base metal moves in the direction of the weld bead.</p>			
Possible Causes	Corrective Actions		
Excessive heat input.	Use restraint (clamp) to hold base metal in position.		
	Make tack welds along joint before starting welding operation.		
	Select lower voltage range and/or reduce wire feed speed.		
	Increase travel speed.		
	Weld in small segments and allow cooling between welds.		

7-16. Common MIG Shielding Gases

This is a general chart for common gases and where they are used. Many different combinations (mixtures) of shielding gases have been developed over the years. The most commonly used shielding gases are listed in the following table.

Gas	Application			
	Spray Arc Steel	Short Circuiting Steel	Short Circuiting Stainless Steel	Short Circuiting Aluminum
Argon				All Positions
Argon + 25% CO ₂	Flat & Horizontal ¹ Fillet	All Positions	All Positions ²	
CO ₂	Flat & Horizontal ¹ Fillet	All Positions		
Tri-Mix ³			All Positions	

1 Globular Transfer

2 Single Pass Welding Only

3 90% HE + 7-1/2% AR + 2-1/2% CO₂

SECTION 8 – PARTS LIST

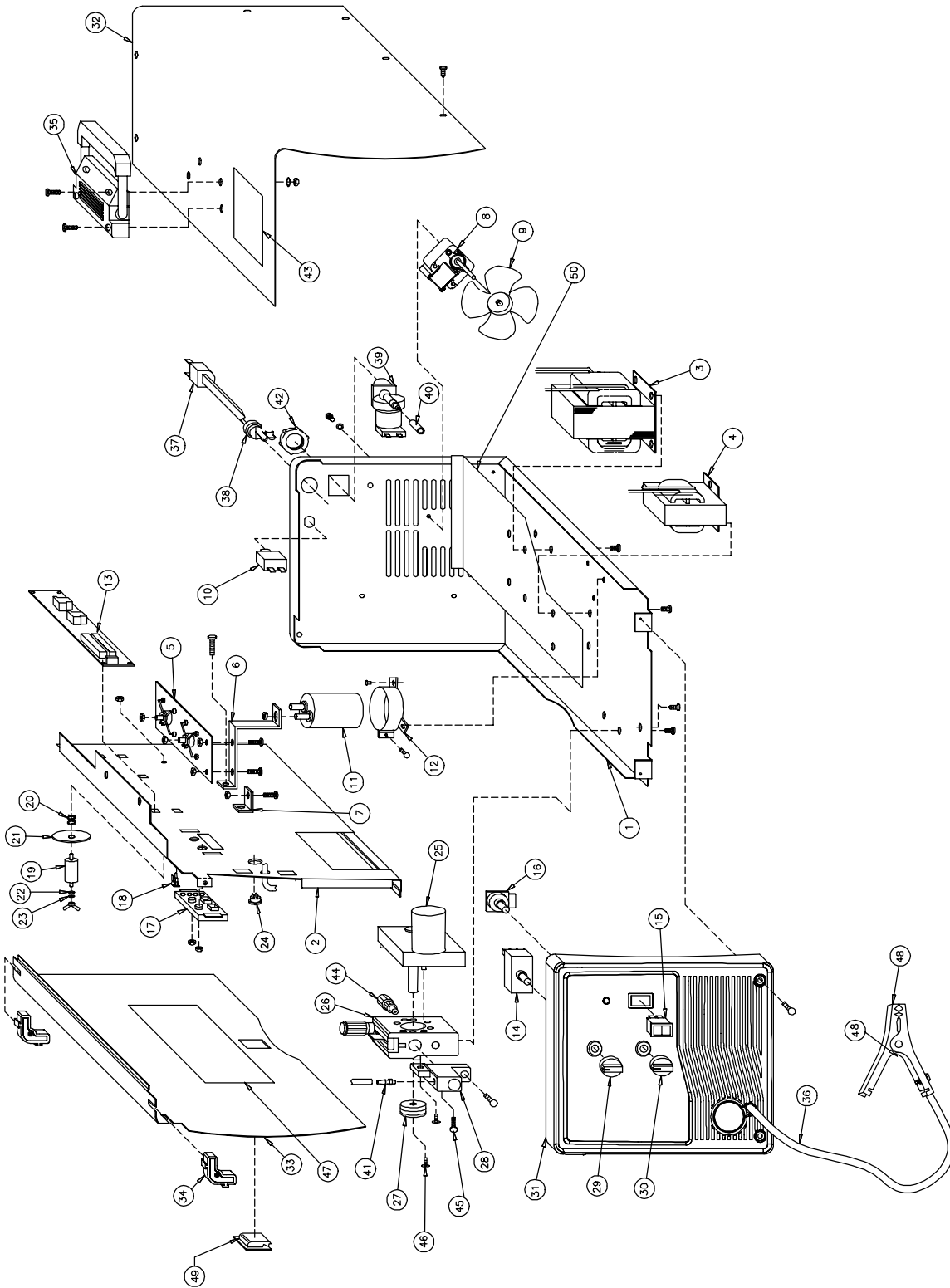

☐ Hardware is common and not available unless listed.

Figure 8-1. Main Assembly

Item No.	Dia. Mkgs.	Part No.	Description	Quantity
----------	------------	----------	-------------	----------

Figure 8-1. Main Assembly

... 1		195 999	BASE, lower	1
... 2		196 000	BAFFLE, center	1
... 3		194 268	TRANSFORMER, power assy (115 VAC model)	1
... 3		194 277	TRANSFORMER, power assy (230 VAC model)	1
... 4		194 274	REACTOR ASSY (115 VAC model)	1
... 4		194 279	REACTOR ASSY (230 VAC model)	1
... 5		193 191	RECTIFIER ASSY (115 VAC model)	1
... 5		193 316	RECTIFIER ASSY (230 VAC model)	1
... 6		193 193	BUS BAR (positive)	1
... 7		193 194	BUS BAR (negative)	1
... 8		196 063	MOTOR, fan (115 VAC model)	1
... 8		196 064	MOTOR, fan (230 VAC model)	1
... 9	409	953-001	BLADE, fan cooling	1
... 10		210 109	CIRCUIT BREAKER, 25 amp	1
... 11		193 039	CAPACITOR, electlt 53000uf (115 VAC model)	1
... 11		193 040	CAPACITOR, electrlt 100000uf (230 VAC model)	1
... 12		193 072	CLAMP, capacitor	1
... 13		195 886	CIRCUIT CARD ASSY, control (115 VAC model)	1
... 13		195 887	CIRCUIT CARD ASSY, control (230 VAC model)	1
... 14		409 477	SWITCH, rotary 25A 5 position	1
... 15		196 575	SWITCH, rocker SPST (115 VAC model)	1
... 15		196 574	SWITCH, rocker DPST (230 VAC model)	1
... 16		194 513	POTENTIOMETER,	1
... 17		193 144	INSULATOR, output stud	1
... 18		134 201	STAND-OFF	1
... 19		203 556	SHAFT, spool hub	1
... 20	409	615-002	WASHER, spring finger	1
... 21		203 555	WASHER, brake	1
... 22	407	611-002	WASHER, flat nylon	1
... 23		203 666	WASHER, brake	1
... 24	405	576-001	BUSHING, terminal	1
... 25		193 187	MOTOR, gear	1
... 26		194 508	HEAD, feed assy	1
... 27	407	230-001	ROLL, feed .024 in, .030/.035 in	1
... 28		193 189	CONNECTOR, gun	1
... 29		186 217	KNOB, pointer (voltage)	1
... 30		193 237	KNOB, pointer (WFS)	1
... 31		196 007	PANEL, front (black)	1
... 32		196 005	WRAPPER	1
... 33		199 566	DOOR, access	1
... 34		196 006	HINGE, door	1
... 35		195 585	HANDLE, carrying	1
... 36		196 619	CABLE, work	1
... 37		147 545	CABLE, power assy (115 VAC model)	1
... 37		152 118	CABLE, power assy (230 VAC model)	1

Item No.	Dia. Mkgs.	Part No.	Description	Quantity
----------	------------	----------	-------------	----------

Figure 8-1. Main Assembly (Continued)

... 38	...	111 443	... BUSHING, strain relief	1
... 39	...	116 996	... VALVE, gas (115 VAC model)	1
... 39	...	128 751	... VALVE, gas (230 VAC model)	1
... 40	...	196 467	... TUBING, gas	1
... 41	...	196 009	... FITTING, gas barbed	1
... 42	...	605 227	... NUT, gas valve	1
... 43	...	204 036	... LABEL, warning	1
... 44	...	203 025	... GUIDE, wire inlet	1
... 45	...	196 654	... SCREW, thumb	1
... 46	...	203 081	... SCREW, feed roll	1
... 47	...	196 052	... LABEL, weld chart (115 VAC model)	1
... 47	...	196 081	... LABEL, weld chart (230 VAC model)	1
... 48	...	010368	... CLAMP, work	1
... 49	...	089 899	... LATCH	1
... 50	...	198 585	... PLATE, support (230 VAC model only)	1

+When ordering a component originally displaying a precautionary label, the label should also be ordered.

To maintain the factory original performance of your equipment, use only Manufacturer's Suggested Replacement Parts. Model and serial number required when ordering parts from your local distributor.

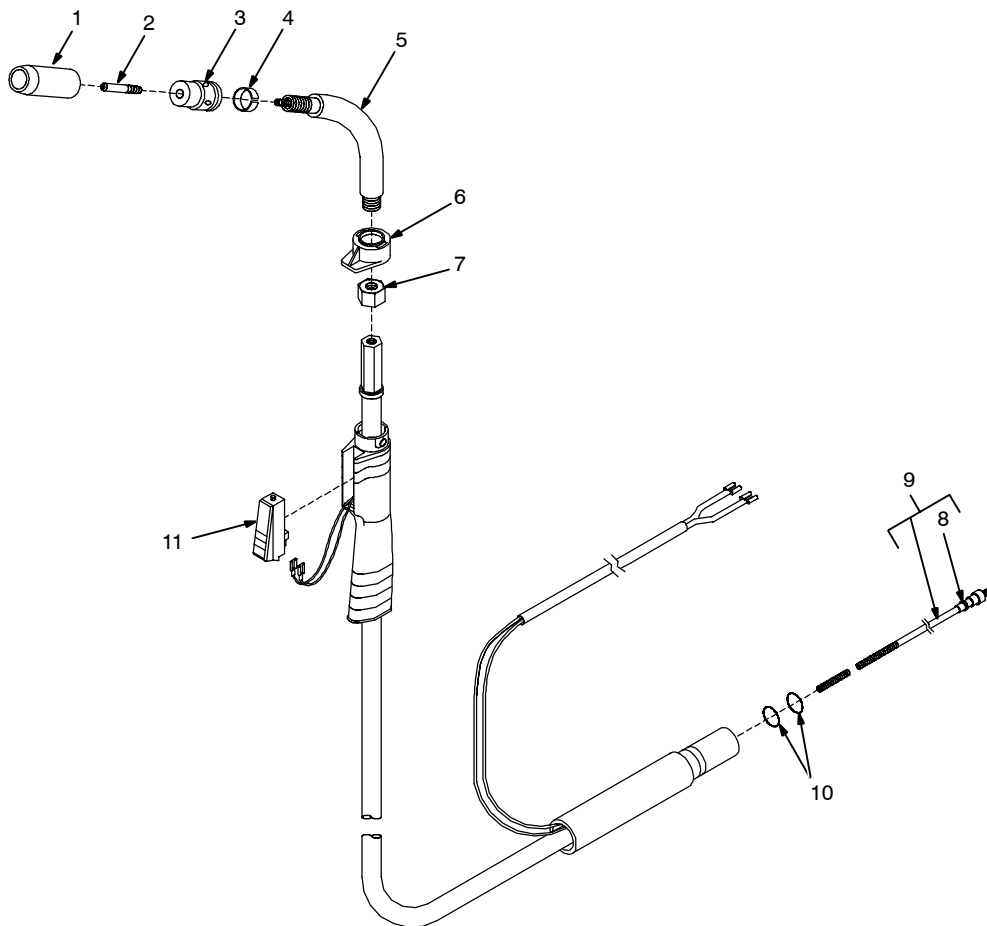

Figure 8-2. Gun

802 447

Item No.	Part No.	Description	Quantity
042 053		Figure 8-2. Gun	
... 1	130 789	NOZZLE, slip type .500 orf flush	1
... 2	◆130 792	TIP, contact scr .023 wire x 1.125	
... 2	◆130 794	TIP, contact scr .030 wire x 1.125	
... 2	◆130 796	TIP, contact scr .035 wire x 1.125	
... 2	◆130 798	TIP, contact scr .045 wire x 1.125	
... 3	169 716	ADAPTER, contact tip	1
... 4	170 470	RING, retaining	1
... 5	169 718	TUBE, head	1
... 6	169 738	NUT, locking handle	1
... 7	194 524	NUT, jam	1
... 8	079 975	O-RING, .187 ID x .103CS rbr	1
... 9	◆194 010	LINER, monocoil .023/.025 wire x 15ft (consisting of)	1
... 9	◆194 011	LINER, monocoil .030/.035 wire x 15ft (consisting of)	1
... 9	◆194 012	LINER, monocoil .035/.045 wire x 15ft (consisting of)	1
... 9	◆194 014	LINER, monocoil 4/64 AL wire x 10ft nyl(consisting of)	1
... 10	197 123	O-RING, .312 ID x .062 70 Dura BUNA-N	2
... 11	196 255	SWITCH, trigger	1

◆OPTIONAL

To maintain the factory original performance of your equipment, use only Manufacturer's Suggested Replacement Parts. Model and serial number required when ordering parts from your local distributor.

Table 8-1. Optional Drive Rolls

For All Feed Head Assemblies	
PART NO.	WIRE DIAMETER INCHES (mm)
407 230-1	.024 (.6) and .030/.035 (.8 and .9)
407 230-4	.024 (.6) and .045 (1.2)

NOTE: If individual parts are required, see Parts List chapter of this manual for part number to order or for further assistance contact:

Milweld Inc., National Distributor
P.O. Box 338, Hortonville, WI 54944-0338
Tel (920) 779-0916 Fax (920) 779-0924

Warranty

Effective January 1, 2000
(Equipment with a serial number preface of "LA" or newer)

This limited warranty supersedes all previous manufacturers warranties and is exclusive with no other guarantees or warranties expressed or implied.

LIMITED WARRANTY – Subject to the terms and conditions below, warrants to its original retail purchaser that new equipment sold after the effective date of this limited warranty is free of defects in material and workmanship at the time it is shipped from factory. THIS WARRANTY IS EXPRESSLY IN LIEU OF ALL OTHER WARRANTIES, EXPRESS OR IMPLIED, INCLUDING THE WARRANTIES OF MERCHANTABILITY AND FITNESS.

Within the warranty periods listed below, manufacturer will repair or replace any warranted parts or components that fail due to such defects in material or workmanship. Manufacturer must be notified in writing within thirty (30) days of such defect or failure, at which time manufacturer will provide instructions on the warranty claim procedures to be followed.

Manufacturer shall honor warranty claims on warranted equipment listed below in the event of such a failure within the warranty time periods. All warranty time periods start on the date that the equipment was delivered to the original retail purchaser, or one year after the equipment is sent to the distributor.

1. 5 Years Parts – 3 Years Labor
 - * Original main power rectifiers
2. 3 Years — Parts and Labor
 - * Transformer/Rectifier Power Sources
 - * Plasma Arc Cutting Power Sources
 - * Semi-Automatic and Automatic Wire Feeders
 - * Engine Driven Welding Generators
(NOTE: Engines are warranted separately by the engine manufacturer.)
3. 1 Year — Parts and Labor
 - * Motor Driven Guns (w/exception of Spoolmate 185)
 - * Process Controllers
 - * Positioners and Controllers
 - * Automatic Motion Devices
 - * Robots
 - * RFCS Foot Controls
 - * Induction Heating Power Sources
 - * Water Coolant Systems
 - * HF Units
 - * Grids
 - * Spot Welders
 - * Load Banks
 - * SDX Transformers
 - * Running Gear/Trailers
 - * Field Options
(NOTE: Field options are covered under the limited warranty for the remaining warranty period of the product they are installed in, or for a minimum of one year — whichever is greater.)
4. 6 Months — Batteries
5. 90 Days — Parts and Labor
 - * MIG Guns/TIG Torches
 - * Induction Heating Coils and Blankets
 - * Plasma Cutting Torches
 - * Remote Controls
 - * Accessory Kits
 - * Replacement Parts
 - * Spoolmate 185

Limited Warranty shall not apply to:

1. Items furnished by manufacturer, but manufactured by others, such as engines or trade accessories. These items are covered by the manufacturer's warranty, if any.
2. Consumable components; such as contact tips, cutting nozzles, contactors, relays, brushes, slip rings, or parts that fail due to normal wear.
3. Equipment that has been modified by any party other than manufacturer, or equipment that has been improperly installed, improperly operated or misused based upon industry standards, or equipment which has not had reasonable and necessary maintenance, or equipment which has been used for operation outside of the specifications for the equipment.

MANUFACTURER'S PRODUCTS ARE INTENDED FOR PURCHASE AND USE BY COMMERCIAL/INDUSTRIAL USERS AND PERSONS TRAINED AND EXPERIENCED IN THE USE AND MAINTENANCE OF WELDING EQUIPMENT.

In the event of a warranty claim covered by this warranty, the exclusive remedies shall be, at manufacturers option: (1) repair; or (2) replacement; or, where authorized in writing by manufacturer in appropriate cases, (3) the reasonable cost of repair or replacement at an authorized service station; or (4) payment of or credit for the purchase price (less reasonable depreciation based upon actual use) upon return of the goods at customer's risk and expense. manufacturer's option of repair or replacement will be F.O.B., Factory at Appleton, Wisconsin, or F.O.B. at an authorized service facility as determined by manufacturer. Therefore no compensation or reimbursement for transportation costs of any kind will be allowed.

TO THE EXTENT PERMITTED BY LAW, THE REMEDIES PROVIDED HEREIN ARE THE SOLE AND EXCLUSIVE REMEDIES. IN NO EVENT SHALL MANUFACTURER BE LIABLE FOR DIRECT, INDIRECT, SPECIAL, INCIDENTAL OR CONSEQUENTIAL DAMAGES (INCLUDING LOSS OF PROFIT), WHETHER BASED ON CONTRACT, TORT OR ANY OTHER LEGAL THEORY.

ANY EXPRESS WARRANTY NOT PROVIDED HEREIN AND ANY IMPLIED WARRANTY, GUARANTY OR REPRESENTATION AS TO PERFORMANCE, AND ANY REMEDY FOR BREACH OF CONTRACT TORT OR ANY OTHER LEGAL THEORY WHICH, BUT FOR THIS PROVISION, MIGHT ARISE BY IMPLICATION, OPERATION OF LAW, CUSTOM OF TRADE OR COURSE OF DEALING, INCLUDING ANY IMPLIED WARRANTY OF MERCHANTABILITY OR FITNESS FOR PARTICULAR PURPOSE, WITH RESPECT TO ANY AND ALL EQUIPMENT FURNISHED BY MANUFACTURER IS EXCLUDED AND DISCLAIMED BY MANUFACTURER.

Some states in the U.S.A. do not allow limitations of how long an implied warranty lasts, or the exclusion of incidental, indirect, special or consequential damages, so the above limitation or exclusion may not apply to you. This warranty provides specific legal rights, and other rights may be available, but may vary from state to state.

In Canada, legislation in some provinces provides for certain additional warranties or remedies other than as stated herein, and to the extent that they may not be waived, the limitations and exclusions set out above may not apply. This Limited Warranty provides specific legal rights, and other rights may be available, but may vary from province to province.



Owner's Record

Please complete and retain with your personal records.

Model Name

Serial/Style Number

Purchase Date

(Date which equipment was delivered to original customer.)

Distributor

Address

City

State

Zip



Resources Available

Always provide Model Name and Serial/Style Number.

Contact your Distributor for:

Welding Supplies and Consumables

Options and Accessories

Personal Safety Equipment

Service and Repair

Replacement Parts

Owner's Manuals

Circuit Diagrams

Contact the Delivering Carrier for:

File a claim for loss or damage during shipment.

For assistance in filing or settling claims, contact your distributor and/or equipment manufacturer's Transportation Department.